

LANCER
CPD 502

(CONSTANT TORQUE INVERTER)

M *MagneTek*
Drives & Systems

INSTALLATION/START-UP INSTRUCTIONS

INTRODUCTION

Use these procedures, along with the wiring diagram identified on the unit nameplate to install, wire and initially start up the BASIC Louis Allis Drive.

SPECIFICATIONS

Refer to unit nameplate.

INSTALLATION SITE REQUIREMENTS

Ambient Temperature	-10 to 40°C
Relative Humidity	Less than 90%, Noncondensing
Vibration	Less than 0.2G

The Drive must be installed indoors in an upright level position protected from corrosive gases and dust. See Figure 1 for minimum free air space requirements.

INITIAL INSPECTION

Upon receipt of your Lancer GPD 602, a careful inspection for shipping damage should be made. After uncrating, check:

- Whether any parts are loose, broken or separated.
- Whether the rated capacity shown on the nameplate is the same as specified on your order.

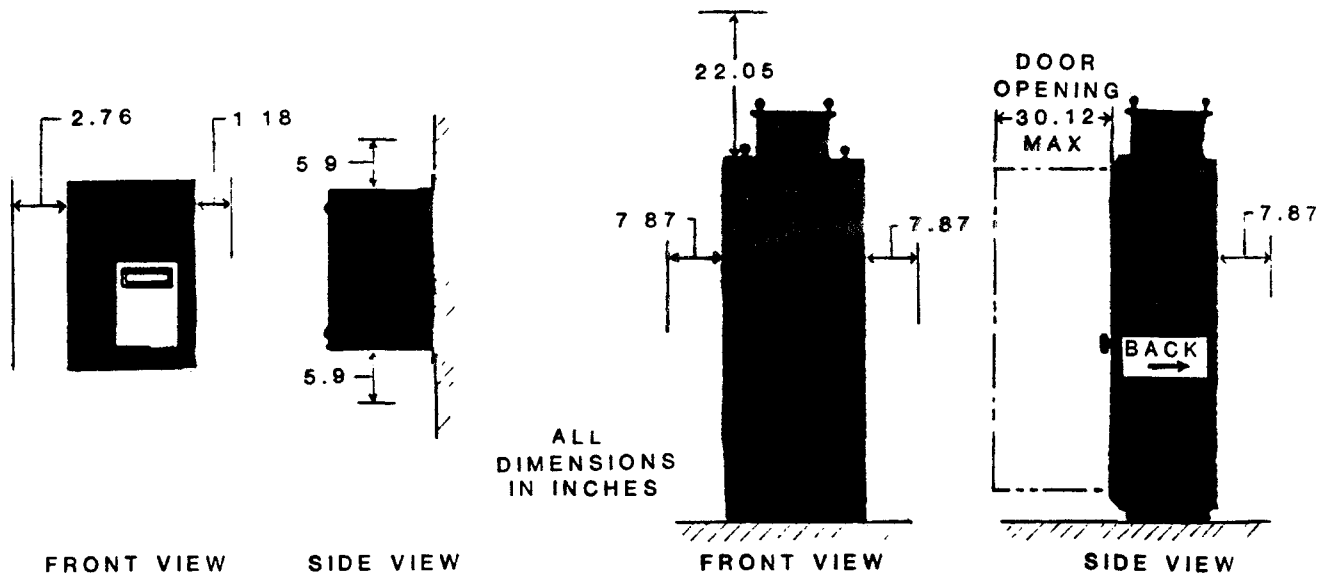

Figure 1.

CHANGE RECORD				DWG. NO. 02Y00025-0247 SHEET 1 OF 7 EFF. 11/9/87 (0)
1	STD-3002	3/15/88		
2	STD-3067	5/16/88		

Any damages or shortages evident when the equipment is received must be reported immediately to the commercial carrier who transported the equipment. Assistance, if required, is available from the nearest Louis Allis District Office. Always refer to the Louis Allis order number, equipment description, and number stamped on the unit nameplate when contacting Louis Allis Drives & Systems.

For repacking, refer to the unit's Reference Manual.

PRECAUTIONS

A. Exercise caution when attempting to wire, adjust, test, service, or repair the Lancer GPD 602 Drive. When the "CHARGE" LED is lit, hazardous DC bus cap potential still exists. After the "CHARGE" LED goes out, verify that there is no longer a charge by measuring from terminal N(-) to terminal P (230V, 5-10HP) or P3 (across the Main Circuit capacitor) with a voltmeter.

B. Removal of covers exposes voltages which are hazardous to life. Covers may be left off ONLY IF the Drive is mounted in a NEMA enclosure.

C. NEVER connect power factor correction capacitors across the Drive output and the motor. This will result in high currents and equipment damage.

D. NEVER connect power factor correction capacitors across input power source without first consulting Louis Allis. Improper use will result in equipment damage.

E. NEVER adjust SPEED pot fully clockwise before first checking the mechanical limitations of your equipment.

F. NEVER move, lift, or handle a wall-mount unit by its front cover.

INSTALLATION - MECHANICAL (Drives rated 60HP and below, 230V, 100HP and below, 460V)

Remove the front cover from the unit and install to wall or panel, using the mounting holes at the rear of the unit.

INSTALLATION - ELECTRICAL (Refer to the wiring diagram identified on the unit nameplate)

IMPORTANT

For equipment stored six months or more, special care must be taken during start-up to minimize the chance of failure of the electrolytic filter capacitor. Refer to the Reference Manual for instructions.

NOTE

When installing the Drive in a control panel with other magnetic contactors or relays, connect a noise suppressor across the coil of each component.

IMPORTANT

Do not make connections to motor until specified in START-UP procedure.

A. Installation and interconnection wiring must be done in conformance with the National Electrical Code, regulations of the Occupational Safety and Health Administration, and/or other national, regional, or industry codes and standards.

B. In long cable runs, size wire to avoid excessive voltage drop.

C. The leads used for speed reference, feedback, and other low level signals must be shielded cable and placed in conduit which is separate from conduit used for the motor and AC power leads.

DWG. NO. 02Y00025-0247
SHEET 2 OF 7
EFF. 11/9/87 (0)

D. Connect the shields of shielded cable at the DRIVE END ONLY. The far end of the shield is to be dressed neatly and left unconnected.

E. Connect terminal E (GND) to an appropriate earth ground.

F. A fused disconnect or a 3-phase circuit breaker (ICB) connected to the incoming AC line and located near the Drive is recommended to serve as a suitable means of removing and applying input voltage to the Drive. If an input isolation transformer is used, locate the fused disconnect or circuit breaker between the transformer secondary and the Drive.

G. Installation of a motor overload relay (10L) between the Drive output and the motor is recommended to provide overload protection to the motor. Motor thermal switches (thermoguards) are a suitable substitute for overload relay if available.

OPERATOR CONTROLS

The basic Lancer GPD 602 Drive is not equipped with operator controls. The user has the option of ordering either an integral-mounting Louis Allis Digital Operator, Programming Operator, Analog Operator or a Louis Allis remote Operator Control Station. The user can also interface their system logic with the Drive.

If operator control is a(n):

- a. Analog Operator - see instruction sheet 02Y00025-0248
- b. Digital Operator - see instruction sheet 02Y00025-0249
- c. Programming Operator - see instruction sheet 02Y00025-0250
- d. Remote OCS or Customer System Logic - see Drive wiring diagram

for appropriate installation/wiring requirements.

IMPORTANT

The customer system relay logic will determine how the Drive will respond following a power outage or fault shutdown.

STATUS DISPLAY (Figure 2)

A. "RUN"/"FAULT" LEDs (LD1/F1 (LD2) & F2 (LD4)) display operating or fault status code for the Drive whenever power is applied. Refer to unit's Reference Manual for explanation of fault codes.

When an Analog, Digital, or Programming Operator is used, faults are indicated on the Operator's front panel.

B. RESET - When the Drive has been shut down by a fault condition, while power is still applied, the fault is annunciated by a sequential flashing of either or both FAULT F1 and F2 LEDs, and the fault relay is energized. While energized it will prevent restart of the Drive. The relay can be reset by pressing the RESET push button, or by the RESET function on any optional Operator which is present.

If input power was removed for troubleshooting and repair, the relay is automatically reset when power is reapplied.

PREPOWER CHECKS

Before applying input power, verify:

1. Wires are properly connected and no erroneous grounds exist.
2. Source voltage matches unit nameplate rating, $\pm 10\%$.
3. All debris inside enclosure is removed.
4. All mechanical connections inside unit are tight.

DWG. NO. 02Y00025-0247
SHEET 3 OF 7
EFF. 11/9/87 (0)

NOTE

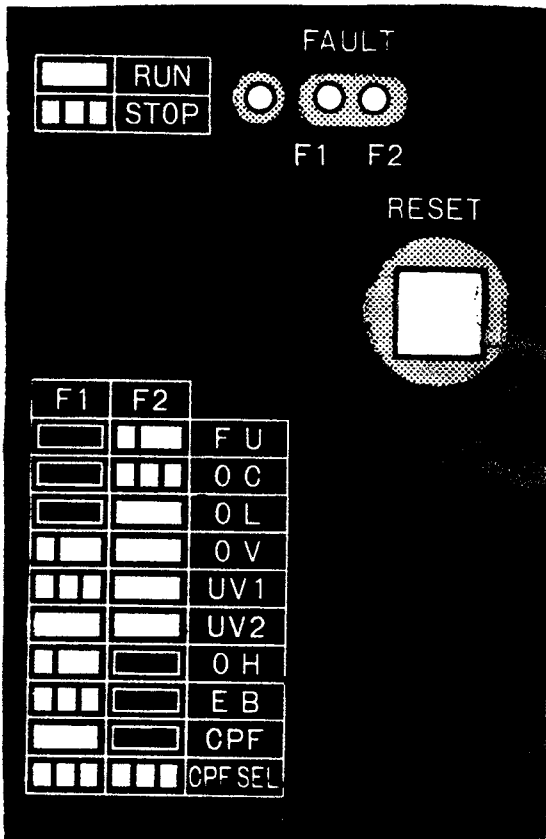

Figure 2.

START-UP

1. Initial conditions (no power applied):
 - a. SPEED pot set to minimum (fully CCW).
 - b. RUN-STOP switch/push button in STOP.
 - c. Drive disconnected from motor.

NOTE

If Drive shutdown occurs during operation, refer to TROUBLESHOOTING procedures in Reference Manual.

All following steps assume that external control signal input is used (remote OCS or customer system logic). If an optional Operator is present, controls and indications will be different, according to description in the Operator's instructions sheet.

2. Apply input power. The "CHARGE" lamp should glow, and the "RUN" LED should blink in short flashes, and the fan should begin to operate. (Not all units utilize a fan for cooling.) Place the RUN-STOP switch/push button to RUN. The "RUN" LED should light steadily. Turn SPEED pot slightly CW. The Drive should begin to operate, as indicated by motor speed meter.

3. Slowly increase SPEED pot to maximum (fully CW), while monitoring the FAULT LEDs. Leave setting at full speed and place RUN-STOP switch/push button to STOP. Drive should decelerate smoothly, at a rate determined by the setting of internal DEC pot. Place RUN-STOP switch/push button back to RUN. Drive should accelerate smoothly to full speed at a rate determined by the setting of internal ACC pot.

4. Turn SPEED pot to minimum (fully CCW). After Drive stops, place RUN-STOP switch/push button to STOP.

5. Turn off input power.

6. With motor disconnected from load, make wiring connections to motor.

7. Apply power. Place RUN-STOP switch/push button to RUN position and turn SPEED pot slightly CW; the motor should start turning. If motor runs backward, stop the Drive, turn off power, and reverse any two connections at Drive output terminals (T1, T2 and T3).

DWG. NO. 02Y00025-0247
 SHEET 4 OF 7
 EFF. 11/9/87 (0)

8. Connect motor to load.

CAUTION

NEVER ROTATE SPEED POT FULLY CLOCKWISE BEFORE FIRST CHECKING THE MECHANICAL LIMITATIONS OF YOUR EQUIPMENT.

9. Slowly increase SPEED pot to maximum (fully CW), while monitoring motor operation. Leave setting at full speed and place RUN-STOP switch/push button to STOP. Motor should decelerate without tripping off. Place RUN-STOP switch/push button back to RUN. Motor should accelerate smoothly to full speed without tripping.

10. Check motor current at several different speed settings. Continuous currents above motor full load rating may damage the motor.

11. Start-up is now complete.

ADJUSTMENT PROCEDURE

The Lancer GPD 602 Drive comes pre-adjusted from the factory. The only adjustments that may need to be changed before drive operation are 2S, accel time (ACC), and decel time (DEC).

Refer to Drive wiring diagram, Reference Manual and decal on inside of Drive front cover for factory settings.

IMPORTANT

The Lancer GPD 602 Drive is shipped calibrated for 1.5 to 60HZ operation.

PRECAUTIONS:

A. When power is on, high voltage is applied to the Control PCB. To connect or disconnected test equipment:

1. Disconnect all input power.
2. Wait at least 5 minutes.
3. Check that the "CHARGE" LED is extinguished.

CAUTION

THE "CHARGE" LED BEING ILLUMINATED IMPLIES THAT HAZARDOUS DC BUS CAP POTENTIAL STILL EXISTS. AS AN ADDED SAFETY MEASURE, AFTER THE "CHARGE" LED EXTINGUISHES. VERIFY THAT THERE IS NO LONGER A CHARGE BY MEASURING THE POTENTIAL FROM TERMINAL N(-) TO TERMINAL P(230V, 5-10HP) OR P3 (ACROSS MAIN CIRCUIT CAPACITOR) WITH A VOLTMETER.

B. Do not ground any test instruments when connecting, and ensure the input impedance of these devices is 1M ohms or greater.

WARNING

ADJUSTING THE DRIVE WITH POWER ON REQUIRES SPECIAL PRECAUTIONS: ALL TEST EQUIPMENT SHOULD BE CONNECTED AND DISCONNECTED WITH POWER OFF. HIGH VOLTAGE EXISTS ON THE REGULATOR BOARD; ALL POTENTIOMETERS SHOULD BE ADJUSTED WITH INSULATED HANDLE SCREW-DRIVERS. IMPROPER USE OF GROUNDED TEST EQUIPMENT MAY DAMAGE THE DRIVE. ENSURE THAT TEST EQUIPMENT IS CONNECTED PROPERLY TO AVOID GROUNDING THE DRIVE. THE DC BUS REMAINS CHARGED FOR SEVERAL MINUTES AFTER POWER IS REMOVED.

DWG. NO. 02Y00025-0247
SHEET 5 OF 7
EFF. 11/9/87 (0)

CHART

SWITCH	SELECTABLE FEATURES	NOTCH	ON	OFF
1S	Volts/hertz curves (See Reference Manual)			
2S	Accel/decel time range			
3S	Sequence mode selector (CAUTION: DO NOT TAMPER)			
4S	Electronic thermal overload protection (consult Louis Allis representative)			
5S	Drive capacity (CAUTION: DO NOT TAMPER)			
6S	DC injection during stop. Motor coasts below 1/40 of rated speed.	1 1		x
	Controlled deceleration. Coast to rest.	2 2	x	x
	DB Resistor option not present. DB Resistor option present.	3 3	x	x
	DC injection before starting (anti-windmilling). Normal accel operation.	4 4	x	x
	Motor coasts to a stop after momentary power failure. Maximum power ride-thru.	5 5	x	x
	Speed search operation. Speed search over-ride.	6 6	x	x
	Soft jog. Normal jog operation.	7 7	x	x
	Factory set for input voltage. (CAUTION: DO NOT TAMPER)	8		

These switches are located on the Control PCB, RESET ONLY if you need to change factory settings to suit your application.

DWG. NO. 02Y00025-0247
SHEET 6 OF 7
EFF. 11/9/87 (0)

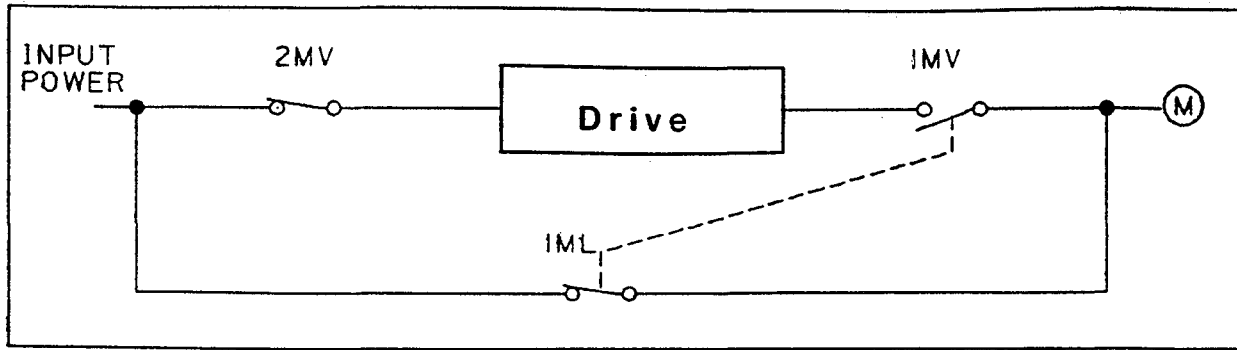

TD.1.2Y25.0246.FIG3

Figure 3. Drive With Full Voltage Bypass

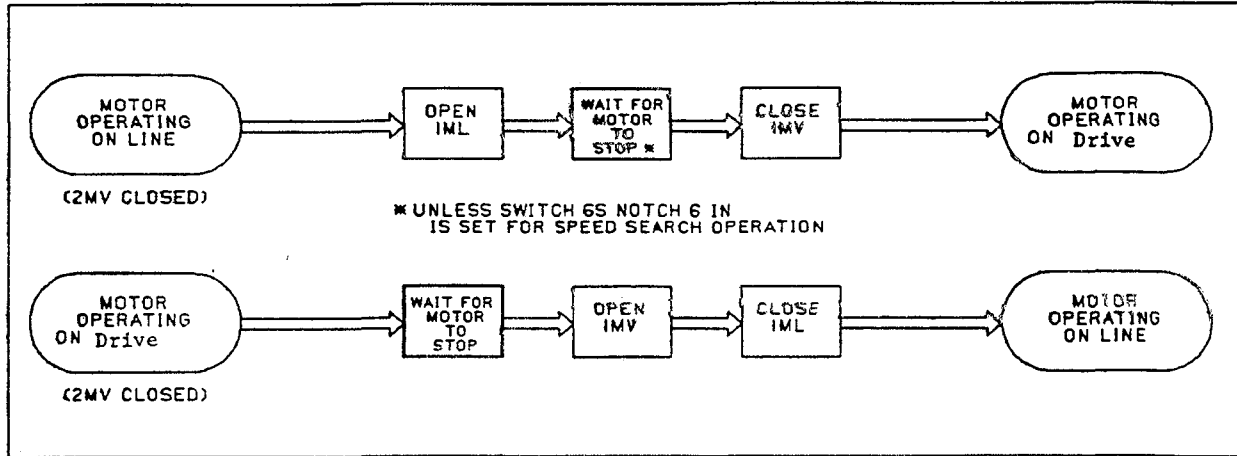

Figure 4. Correct Drive/Line (Bypass) Switching Sequence

BYPASS OPERATION (Figure 3 and Figure 4)

IMPORTANT

CAUTION

2MV IS ALWAYS ENERGIZED

1. NEVER apply input power to Drive output terminals (T1, T2 and T3). Contactors IMV and IML must be electrically interlocked.
2. Accel/Decel time settings must be set for 24 seconds or more. Settings less than this period may result in an overload fault requiring a manual reset.
3. When the Drive is wired for operation with Bypass, verify that motor rotation is the same when powered from either line or Drive.

Failure to verify rotation may result in nuisance trips and possible electrical or mechanical stress.

- a. Open Drive output contactors.
- b. Disconnect motor from load.
- c. "Bump" line contactor and observe motor rotation. If different, open line contactor and switch any two motor leads at the LOAD SIDE of LINE CONTACTOR.
- d. Reconnect motor to load.

DWG. NO. 02Y00025-0247
 SHEET 7 OF 7
 EFF. 11/9/87 (0)

STANDARD
SCHEMATIC/INTERCONNECT
FOLLOWS

NOTES:

* -INDICATES COMPONENTS NOT SUPPLIED.

-INDICATES CUSTOMER CONNECTION TERMINAL, WIRE ONLY TO TERMINALS SHOWN

() -INDICATES ALTERNATE TERMINAL MARKINGS, i.e. (r) AND λ 1

1 THE SWITCHES INDICATE FACTORY SETTING. SWITCHES 5S AND 6S (8) ARE DEPENDENT ON DRIVE CAPACITY AND INPUT VOLTAGE RESPECTIVELY. IS CHANGES THE V/Hz PROFILE WITH A MAXIMUM SETTING OF 180HZ. 2S CHANGES ACCEL/ DECEL TIME RANGE. REFER TO REFERENCE MANUAL FOR ADDITIONAL SETTINGS

5S		DRIVE CAPACITY (HP)							
230V	.5 1	3	5 7.5	10 15	20 25 30	40	50 60	75	
460V	5 1	3	5 7.5	10 15 20	25 30	40	50 60	75 100	
NOTCH	1	2	3	4	5	6	7	8	
230V	100	125							
460V			150		200	250	300,350,400, 450,500,600		
NOTCH	9	A	B	C	D	E	F		

6S		OPERATION MODE	
NOTCH	FUNCTION	SELECTION	
		OFF	ON
8	SUPPLY VOLTAGE (V)	230	460

- 2 AUTO REFERENCE IS FACTORY SET FOR 0 TO 10V INPUT (V) IF 4-20MA IS DESIRED, MOVE JUMPER TO THE (C) POSITION
- 3 TERMINAL λ 3 (t) ONLY APPLIES TO 460V. 125 TO 400HP UNITS TERMINALS λ 1(r) AND λ 2(s) ARE NOT AVAILABLE ON 230V. .5 TO 5HP UNITS JUMPERS ARE FACTORY INSTALLED
- 4 TERMINALS P1 AND P2 ARE NOT AVAILABLE ON 230V. 5 TO 10HP UNITS JUMPERS ARE FACTORY INSTALLED

- 5 WHEN REMOTE OPERATORS ARE USED (IPB), REMOVE JUMPER BETWEEN TERMINALS 1 AND 3
- 6 FOR REMOTE MANUAL SPEED (IRH) ONLY, ADD JUMPER BETWEEN TERMINALS 1 AND 6
- 7. THE LANCER GPD 602 DOES NOT CONTAIN OVERLOAD IOL: IOL IS A SEPARATE ITEM. ALSO, THE CONTACTS FROM THE SEPARATELY SUPPLIED OVERLOAD RELAY SHOULD BE INTERLOCKED WITH THE LANCER GPD 602 AS SHOWN, AND SHOULD BE MANUAL RESET TYPE TO PREVENT AUTOMATIC RESTART FOLLOWING A MOTOR FAULT AND SUBSEQUENT CONTACT RECLOSURE AFTER COOL DOWN
- 8 INSULATED TWISTED SHIELED WIRE IS REQUIRED
2 - CONDUCTOR #18GA (BELDEN #8760 OR EQUIVALENT)
3 - CONDUCTOR #18GA (BELDEN #8770 OR EQUIVALENT)
SHIELD TO BE CONNECTED TO PROPER TERMINAL AS SHOWN. CONNECT SHIELD ONLY AT END STUB AND ISOLATE OTHER END
- 9 REMOTE OPERATORS, AS SHOWN, MAY NOT BE REQUIRED WHEN USING EITHER AN ANALOG OR A DIGITAL OPERATOR. WHEN USING A ANALOG OPERATOR, "R/L" JUMPER NEEDS TO BE PLACED IN "L", WHICH DOES NOT PERMIT USE OF REMOTE MANUAL SPEED REFERENCE
- 10. CUSTOMER TO CONNECT TERMINAL GND (E) TO EARTH GROUND

		Louis Allis Drives & Systems		LANCER GPD 602 CONSTANT TORQUE 230 TO 230V 5 TO 75HP 380 TO 460V 5 TO 600HP
		SHEET 1 OF 1 3Y04465-0020		<input type="checkbox"/>

TABLE OF CONTENTS

<u>SECTION</u>	<u>PAGE</u>
1. RECEIVING	3
2. FUNCTIONAL DESCRIPTION	4
2.1 Functional Block Diagrams	4
2.2 Circuit Operational Description	6
2.2.1 Main Circuit	6
2.2.2 Control Circuit	6
2.2.3 Protective Circuits	7
3. INSTALLATION	8
3.1 Location	8
3.2 Positioning	8
3.3 Mounting Dimensions	9
4. WIRING	13
4.1 Interconnections	13
4.2 Wire Size	13
4.3 Wiring Instructions	15
4.3.1 Control Circuit	15
4.3.2 Main Circuit	15
4.3.3 Grounding	16
4.3.4 Insulation Resistance Test	16
5. CONVERTER ADJUSTMENTS	18
5.1 Location of Adjustments	18
5.2 Description of Adjustments	18
6. MAINTENANCE	27
7. FAILURE INDICATION AND DETAILS	29

TABLE OF CONTENTS

<u>SECTION</u>	<u>PAGE</u>
8 TROUBLESHOOTING	31
8 1 Measuring Points and Instruments	31
APPENDIX 1 RATINGS AND SPECIFICATIONS	45
APPENDIX 2 TERMINAL FUNCTIONS	48
APPENDIX 3 OPTIONS	52
APPENDIX 4 CHECKING OF DIODE AND TRANSISTOR MODULES	53
APPENDIX 5 SPARE PARTS	55

WARNING

AFTER TURNING OFF AC INPUT POWER, AVOID DIRECT CONTACT WITH CIRCUIT COMPONENTS UNTIL "CHARGE" LAMP NO LONGER GLOWS. ATTEMPTING TO WORK ON THE UNIT WHILE THE LAMP IS LIT CAN CAUSE SEVERE ELECTRICAL SHOCK.

BEFORE CHANGING SWITCH SETTINGS (1S THRU 6S), TURN OFF AC INPUT POWER AND CONFIRM THAT THE "CHARGE" LAMP IS NOT GLOWING.

DO NOT CONNECT OR DISCONNECT WIRES AND CONNECTORS WHILE POWER IS APPLIED TO THE UNIT.

IMPORTANT

Be sure to ground the unit using terminal GND (E) (See para 4 3 3). Never connect main circuit output terminals T1, T2, T3 to AC input power

The Lancer GP Converter has been adjusted at the factory. Changes or adjustments should not be attempted until after reading this manual.

Do not hipot any part of this unit. The internal semi-conductors are vulnerable to high voltage and can be severely damaged.

Performing insulation resistance tests with a megger requires special care and safety precautions. (Refer to para 4 3 4).

CAUTION

NEVER CONNECT CAPACITORS ACROSS THE CONVERTER OUTPUT AND MOTOR. UPON APPLICATION OF POWER, THE CONVERTER INITIALLY SEE THE CAPACITORS AS A SHORT CIRCUIT, HIGH CURRENTS RESULT AND EQUIPMENT WILL BE DAMAGED.

IF REQUIRED, POWER FACTOR CORRECITON CAPACITOR NETWORKS MAY BE CONNECTED ACROSS THE INPUT POWER SOURCE ONLY AFTER CONSULTING LOUIS ALLIS.

IMPROPER USE OF POWER FACTOR CORRECTION CAPACITOR NETWORKS WILL DAMAGE EQUIPMENT.

NOTICE

This equipment is exempted from FCC regulations
See 47CFR15.801.

1. RECEIVING

All equipment is tested against defect at Louis Allis. Any damages or shortages evident when the equipment is received must be reported immediately to the commercial carrier who transported the equipment. Assistance, if required, is available from the nearest Louis Allis District Office. Always refer to the Louis Allis order number, equipment description, and serial number when contacting Louis Allis.

2. FUNCTIONAL DESCRIPTION

2.1 Functional Block Diagrams.

TYPICAL 208-230 VOLT UNIT

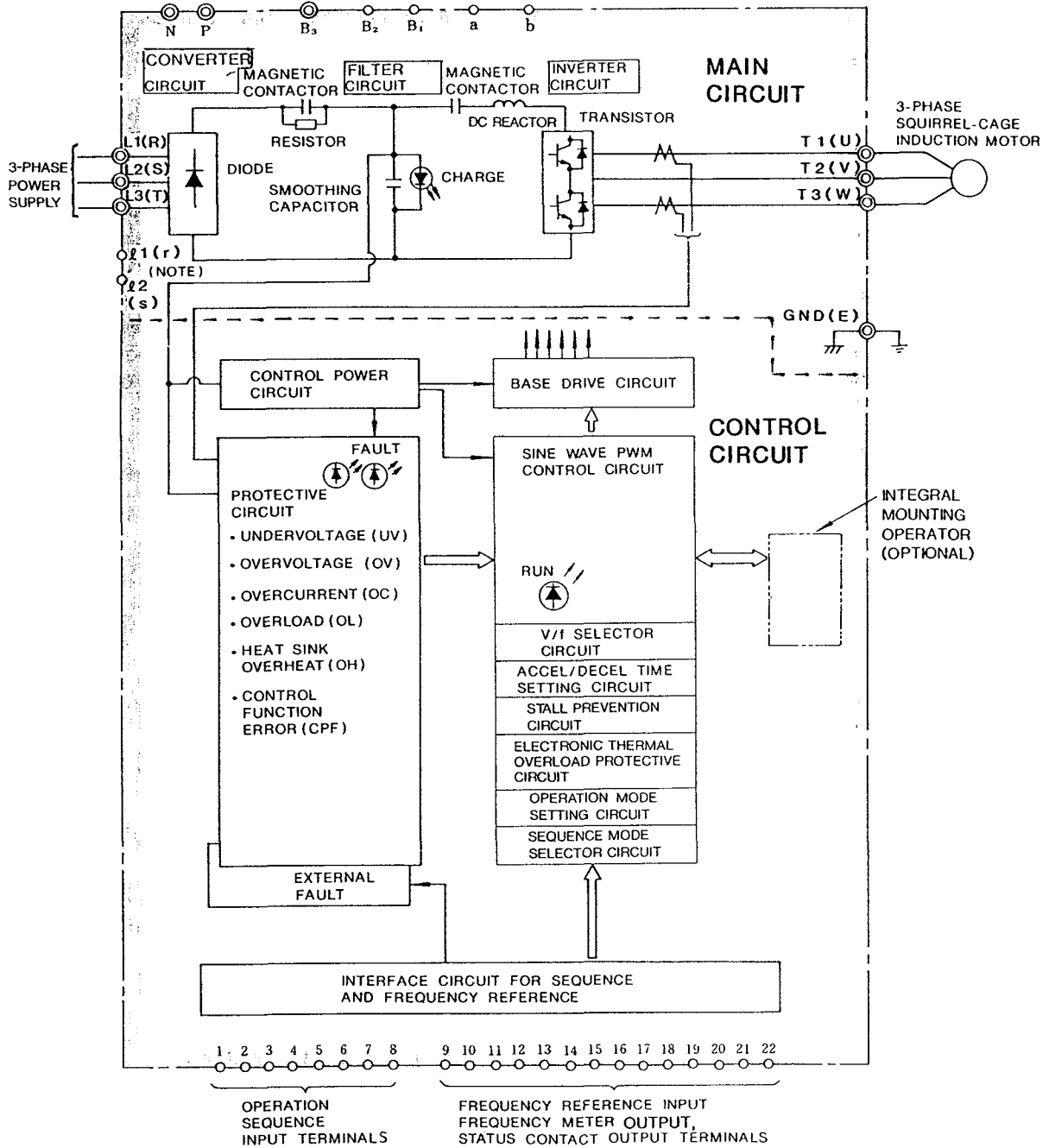

Note: Terminals ①(r) and ②(s) are not provided on 5 to 5 HP units

TYPICAL 380-460 VOLT UNIT

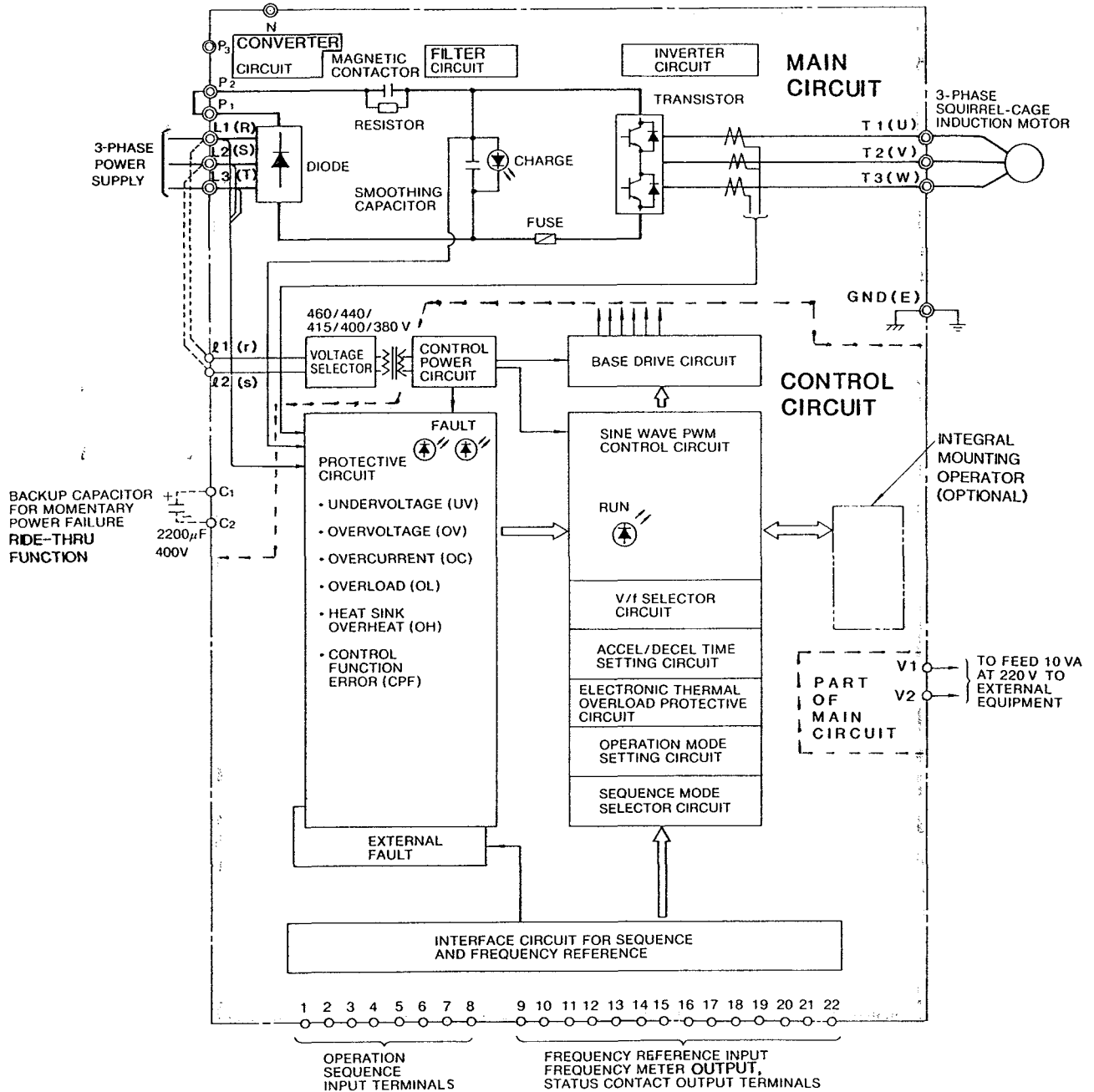

2.2 Circuit Operational Description

2 2.1 Main Circuit

- (1) Converter: Converts three-phase AC input to DC voltage via diode rectification
- (2) Filter: Smooths DC ripple via a capacitor.
- (3) Converter: Converts DC voltage to AC voltage of a preset frequency by switching six transistors. The output voltage level is controlled by changing the pulse width ratio

2 2 2 Control Circuit

- (1) Base drive circuit: Drives the transistors in the converter circuit
- (2) Sine wave PWM control circuit: Calculates the pulse width every time a reference signal is received from the V/f control circuit, and outputs a PWM signal approximating a sine wave.
- (3) V/f selector circuit: Selects V/f pattern from 15 types of built-in voltage/frequency (V/f) patterns (See Figure 3)
- (4) Acceleration and deceleration circuit: Acceleration and deceleration times can be independently set by the acceleration (ACC) and deceleration (DEC) time setting potentiometers (See Figure 4)
- (5) Stall prevention circuit:

During acceleration, acceleration stops in the event of overcurrent condition and prevents the motor from stalling due to overcurrent. When the current returns to the rated value, acceleration is resumed

During deceleration, deceleration stops in the event of overvoltage condition and prevents the motor from stalling due to overvoltage. When the voltage returns to the rated value, deceleration is resumed

In Constant-Speed Operation, motor speed is reduced in the event of an overload condition to prevent the motor from stalling. When the overload condition is cleared, motor resumes running at set speed

- (6) Operation mode selector circuit: Allows selection of eight operation modes, to individually tailor the drive to a specific application

2 2 3 Protective Circuits

NOTE

If a trip condition occurs, refer to Section 8.

- (1) Undervoltage protective circuit: If supply voltage drops below a set level or any one phase* is open, the undervoltage protective circuit shuts off the power transistors in the main circuit and outputs a fault signal (UV operation) With the appropriate operation mode selected, operation can continue during power failures less than .2 seconds or up to 2 seconds with the ride-thru capacitor option. (230 volt units do not require the added capacitor; 2 second ride-thru is standard)
- (2) Overvoltage protective circuit: If the main circuit DC voltage becomes higher than the set level, the overvoltage protective circuit shuts off the power transistors in the main circuit and outputs a fault signal (OV operation)
- (3) Overcurrent protective circuit: If more than 200% of the rated current flow is detected, the overcurrent protective circuit shuts off the power transistors in the main circuit and outputs a fault signal (OC operation)
- (4) Overload protective circuit: When a Converter or motor overload is detected, the overload protective circuit shuts off the power transistors in the main circuit after a specified time and outputs a fault signal (OL operation)
- (5) Electronic thermal overload protective circuit: Automatically adjusts protective characteristics to current and time to maximize operating capability.

* Single phase protection is not available on 230V units rated 10 HP or less

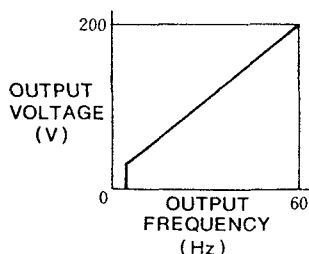

Figure 3. Example of V/f Pattern

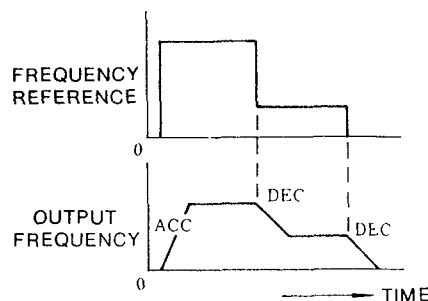

Figure 4. Accel/Decel Time Setting

3. INSTALLATION

3.1 Location

The equipment should be installed in areas where the following conditions exist

- Ambient temperature: -10 to $+40^{\circ}\text{C}$
- Protected from rain or moisture
- Protected from direct sunlight
- Protected from corrosive gases or liquids
- Free from airborne dust or metallic particles
- Free from vibration

CAUTION

NEVER MOVE, LIFT OR HANDLE A WALL-MOUNT BY THE FRONT COVER.

3.2 Positioning

Sufficient clearances must be maintained around the unit for proper cooling and to allow for routine maintenance.

A wall-mounted unit must be installed on a flat vertical and level surface, using mounting holes provided. (See Figure 5)

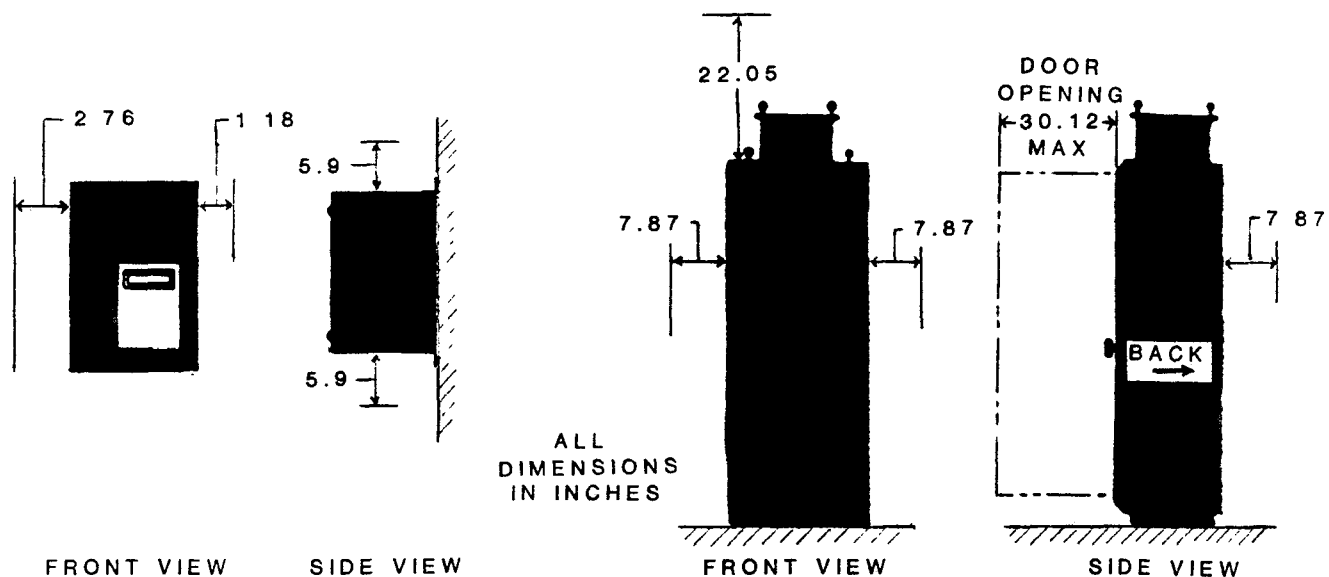

Figure 5.

3.3 Mounting Dimensions

The mounting dimensions for the controls are given in Table 1

Table 1. Installation Dimensions

230 V UNITS							
HP	FIGURE	W	H	D	MOUNTING		
					W1	H1	d
5	6A	7.87	7.87	8 Ø7	6.89	11.42	.187
1	6A	7.87	11.81	8 Ø7	6.89	11.42	.187
3	6A	7.87	11.81	8 Ø7	6.89	11.42	.187
5	6A	7.87	11.81	8.Ø7	6.89	11.42	.187
7.5	6B	7.87	13.78	8.46	4.92	13.39	.187
10	6B	7.87	13.78	8.46	4.92	13.39	.187
15	6B	9.84	19.69	10.Ø4	7.87	19.Ø9	.234
20	6B	12.8Ø	21.65	10.Ø4	10.83	21.Ø6	.234
25	6B	12.8Ø	21.65	10.Ø4	10.83	21.Ø6	.234
30	6B	12.8Ø	21.65	10.Ø4	10.83	21.Ø6	.234
40	6B	12.8Ø	21.65	10.Ø4	10.83	21.Ø6	.234
50	6B	18.7Ø	31.45	11.Ø2	14.76	30.71	.39Ø
60	6B	18.7Ø	31.45	11.Ø2	14.76	30.71	.39Ø
75	6B	18.7Ø	31.45	11.Ø2	14.76	30.71	.39Ø

NOTE: All dimensions are in inches.

Table 1. Installation Dimensions (Continued)

460 V UNITS							
HP	FIGURE	W	H	D	MOUNTING		
					W1	H1	d
5	6A	7.87	13.78	9.25	6.89	13.39	.187
1	6A	7.87	13.78	9.25	6.89	13.39	.187
3	6A	7.87	13.78	9.25	6.89	13.39	.187
5	6A	7.87	13.78	9.25	6.89	13.39	.187
7.5	6B	7.87	15.75	11.42	6.89	15.35	.187
10	6B	7.87	15.75	11.42	6.89	15.35	.187
15	6B	9.84	19.69	12.00	7.87	19.09	.234
20	6B	9.84	19.69	12.00	7.87	19.09	.234
25	6B	9.84	19.69	12.00	7.87	19.09	.234
30	6B	12.80	21.65	10.04	10.43	21.06	.234
40	6B	12.80	21.65	10.04	10.43	21.06	.234

Table 1. Installation Dimensions (Continued)

460 V UNITS (Continued)							
HP	FIGURE	W	H	D	MOUNTING		
					W1	H1	d
50	6B	13.78	28.54	11.02	9.84	27.76	.312
60	6B	13.78	28.54	11.02	9.84	27.76	.312
75	6B	13.78	28.54	11.02	9.84	27.76	.312
100	6B	22.64	36.42	11.02	18.70	35.43	.468
150	6B	22.64	36.42	11.02	18.70	35.43	.468
200	6B	22.64	36.42	11.02	18.70	35.43	.468
250	6C	31.50	91.89	23.62	-	-	-
300	6C	31.50	91.89	23.62	-	-	-
350	6C	86.61	93.70	31.50	-	-	-
400	6C	86.61	93.70	31.50	-	-	-
450	6C	86.61	93.70	31.50	-	-	-
500	6C	86.61	93.70	31.50	-	-	-
600	6C	86.61	93.70	31.50	-	-	-

NOTE: All dimensions are in inches

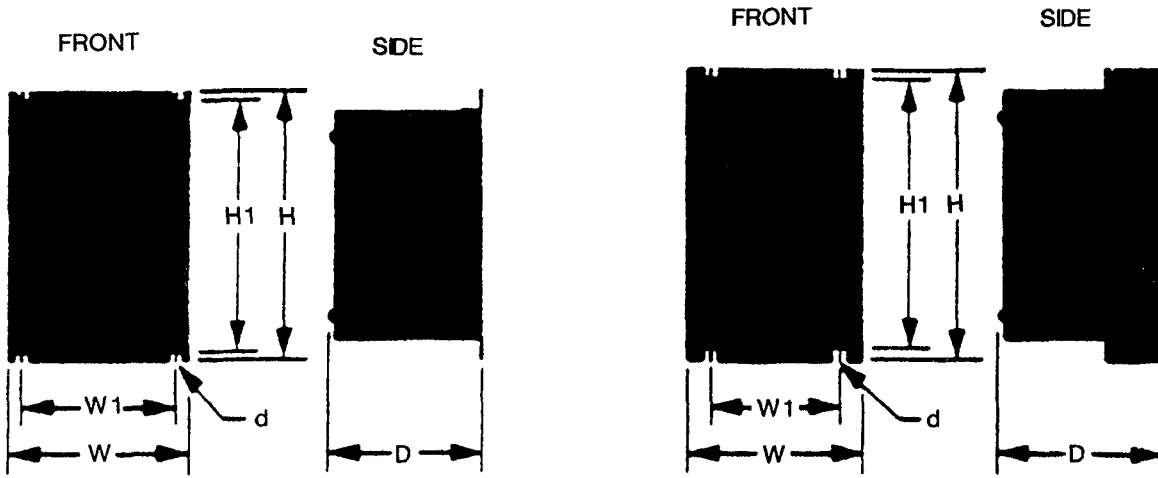

Figure 6A. Small Wall-Mount

Figure 6B. Large Wall-Mount

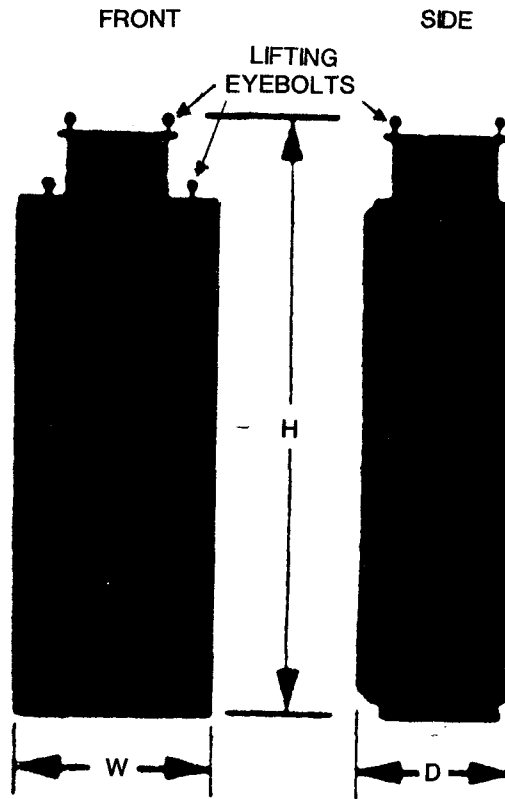

Figure 6C. Floor Standing Cabinet (NEMA 1)

4. WIRING

4.1 Interconnections

The unit nameplate identifies wiring diagrams which support your equipment. Refer to these diagrams for circuit, equipment and interconnection details. If the equipment is modified after installation, the diagrams may have to be updated to reflect changes made.

4.2 Wire Size

Wire sizes for main and control circuits are listed in Table 2. All established Electrical Codes take precedence over these recommendations for input and output wire sizes and motor overload protection.

Table 2. Wire Size for Main and Control Circuits.

230V UNITS		
MAIN CIRCUIT TERMINAL	HP	WIRE SIZE AWG
L1, L2, L3 T1, T2, T3 N (-), P (+), B1, B2, B3, a, b	.5	12
	1	
	3	
	5	
	7.5	
	1Ø	1Ø
L1, L2, L3, T1, T2, T3 N (-), P1, P2, P3	15	8
	2Ø	
	25	4
	3Ø	3
	4Ø	1
	5Ø	ØØ
	6Ø	ØØØ
75	ØØØØ	
Control Circuit Terminals 1-22, r, s	All	2Ø-14
Ground	All	12-4ØØ

460V UNITS		
MAIN CIRCUIT TERMINAL	HP	WIRE SIZE AWG
L1, L2, L3 T1, T2, T3 N (-), P (+), B1, B2, a, b	.5	12
	1	
	3	
	5	
	7.5	
	1Ø	
	15	
	2Ø	1Ø
	25	8
	3Ø	8
L1, L2, L3, T1, T2, T3, N (-), P1, P2, P3	4Ø	6
	5Ø	4
	6Ø	3
	75	1
	1ØØ	ØØØ
	15Ø	ØØØØ
	2ØØ	4ØØ
	25Ø	4ØØ
	3ØØ	6ØØ
	4ØØ	7ØØ
45Ø	7ØØ	
5ØØ	15ØØ	
6ØØ	15ØØ	
Control Circuit Terminals 1-22, r, s, t	All	2Ø-14
Ground	All	12-4ØØ

4.3 Wiring Instructions

Complete interconnections following the instructions given below Check all connections before applying power

4.3.1 Control Circuit

(1) SEPARATION OF CONTROL CIRCUIT LEADS AND MAIN CIRCUIT LEADS

Control circuit leads 1 thru 22 must be separated from main circuit leads L1, L2, L3, N (-), P1, P2, P3, T1, T2, and T3 to prevent erroneous operation caused by noise interference If control circuit leads 12 thru 16 (relay contact output) are connected to an external power supply, it may be necessary to separate them from 1 thru 11 and 17 thru 22.

(2) CONTROL CIRCUIT

Use twisted-pair or shielded leads for the control circuit lines. Connect the shield to control terminals 4, 11, or 19 (See Figure 8)

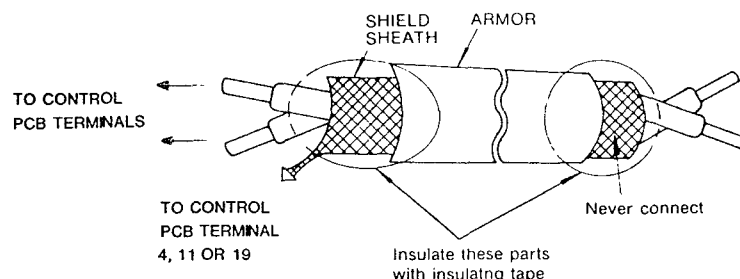

Figure 8. Shielded Lead Termination

(3) WIRING DISTANCE

It is recommended that the wiring distance of the signal leads 1 thru 22 be 164 feet or less.

4.3.2 Main Circuit

(1) PHASE ROTATION OF POWER

Phase rotation of power determines motor rotation

When output terminals T1, T2, and T3 are matched to motor terminals T1, T2, and T3, motor rotation will be counterclockwise viewed from opposite drive end. To reverse the rotation, interchange any two of the motor leads or use the electronic forward/reverse feature built into the drive.

- (2) Never connect input power supply to output terminals T1, T2, and T3.
- (3) Care should be taken to prevent contact of wiring leads with Converter cabinet, as a short-circuit condition may occur.
- (4) Never connect a power factor correction capacitor or noise filter to the Converter output

4 3.3 Grounding

Make a positive ground using the ground terminal GND (E).

- (1) Ground resistance should be 100 ohms or less.
- (2) Never ground the unit to the same common ground as welding machines, motors or other types of large electrical equipment. Run a separate ground lead for the Converter. Make the length as short as possible.
- (3) Even when the unit is grounded through a mounting, such as channel base or steel plate, you must still ground the unit using the ground terminal
- (4) Where several units are used side by side, all the units should be connected directly to ground. However, connecting all the ground terminals of the units together and grounding only one is also permissible (See Figure 9). Do not form a loop with the ground leads.

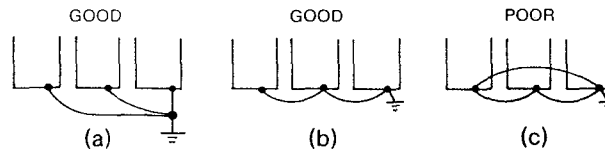

Figure 9. Grounding of Three Units.

4.3 4 Insulation Resistance Test

CAUTION

**NEVER MEASURE THE INSULATION RESISTANCE OF
CIRCUITS OTHER THAN THE MAIN CIRCUIT.**

For megger-testing the main circuit, measure the insulation resistance with a 500V megger (See Figure 10).

- a. Use a common wire to short together all main circuit terminals except GND (E)
- b. Use a common wire to short together all Control PCB terminals except 4, 11 and 19

- c Measure the insulation resistance between the main circuit terminals and ground (terminal GND) A reading above 1 meg-ohm is considered satisfactory.

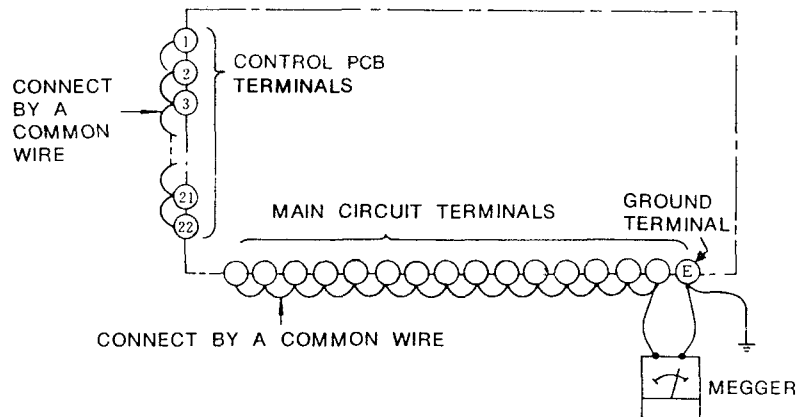

Figure 10. Connections for Megger Testing

5. CONVERTER ADJUSTMENTS

5.1 Location of Adjustments

All internal adjustments for the Converter are located on the Control PC Board and (460V units only) the Voltage Selecting PC Board. The adjustments are listed in Table 3.

5.2 Description of Adjustments









Before making adjustments, shut off AC input power and wait until the "CHARGE" lamp goes out. If any settings, except for accel/decel time, are performed with the power on, the following failure indication will occur:

- Both FAULT lamps (F1 and F2) on the Control PCB blink.
- CPF lamp, or display if the Analog or Digital Operator is used

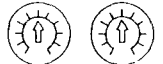
If any settings are changed during operation, operation will continue with the settings made before the change. The new settings will not effect operation until the power is removed, and then reapplied.

- The remote Operator Control Station (OCS) provides no failure indication for changing settings with the power ON

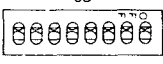
Table 3. List of Converter Adjustments.

Adjustment Name		Symbol	Function	Factory-setting	
Control PC Board (1 PCB)	V/f Pattern Selector Switch	1S 	Selects one of 15 V/f patterns to match specific applications	Notch ①	
	Accel/Decel Time Setting	Switch	2S 	Selects accel/decel time range (0.2 to 1800 seconds)	Notch ①
		Potentiometer	ACC DEC 	Accel/decel times independently adjustable within the time range selected by 2S	Scale 5
	Sequence Mode Selector Switch	3S 	Selects one of 15 types of sequences according to application requirements CAUTION Do not tamper with this switch	Notch ①	
	Electronic Thermal Overload Protective Switch	4S 	Protects motor and Converter from overcurrent conditions if motor capacity is different from Converter capacity	Notch ⑥	
	Converter Capacity Selector Switch	5S 	Set according to Converter capacity CAUTION Do not tamper with this switch	(See Table 8)	
	Operation Mode Selector Switch	6S 	Selects the operation mode according to specific applications	—	
	Auto Frequency Reference Signal Selector Shunt	C V 	Selects either a current signal (4-20mA) or a voltage signal (0-10V) to feed frequency reference signal at terminal ⑨	V (Voltage signal)	
	Manual Frequency Reference Signal Selector Shunt	R L 	Set to input frequency reference at external terminal ⑩ When the Analog Operator is used for frequency setting, set the shunt on "L" because signals from external terminal ⑩ are not accepted	R	

460V unit

Voltage Selecting PC Board (3 PCB)	Voltage Selector Shunt	See Figure 14	Selects voltage according to supply voltage	460 V
	Radio Noise Reducing Filter Circuit Selector Shunt	See Figure 15	Selects radio noise reducing filter circuit according to application A Ground interruptor not used B Ground interruptor used Shuts off ground circuit and prevents malfunction if the interruptor trips	A

(1) Setting of V/f pattern selector switch (1S)

The V/f pattern selector switch (1S) has been factory-set at notch 1. The customer should select the optimum V/f pattern according to his load characteristics (See Table 4)

Table 4. V/f Pattern Selection

Application	Specification	1S Notch	V/f Pattern	Application	Specification	1S Notch	V/f Pattern		
General Purpose	50Hz	①		High Starting Torque	50Hz	Starting Torque Low	⑧		
						Starting Torque High	⑨		
	60Hz	60Hz Saturation	①			60Hz	Starting Torque Low	A	
		50Hz Saturation	②				Starting Torque High	B	
	72Hz		③			90Hz		C	
	Fans and Pumps	50Hz	Variable Torque 2			Machine Tools	120Hz	D	
Variable Torque 1			⑤						
60Hz		Variable Torque 2	⑥		180Hz		E		
		Variable Torque 1	⑦						

Note:

1 Take account of the following conditions and others when selecting V/f pattern:

- Pattern matching the voltage-frequency characteristic of the motor
- According to the maximum motor speed

2 V/f pattern for high starting torque should be selected for:

- Long wiring distance
- Large voltage drop at start
- AC reactor connected to input or output of the Converter
- Use of motor of the rating below the max

3 Patterns shown for 400V input: for other

- inputs, multiply all (V) values shown by the factor (VIN/400)

2) Setting of acceleration and deceleration times (2S, ACC, DEC)

Set the acceleration and deceleration times using the time range selector switch (2S) and the acceleration (ACC) and deceleration (DEC) time setting potentiometers (See Table 5)

2S has been factory-set to notch 1, and the ACC and DEC potentiometers have been individually set to 50% (approximately 10 seconds)

Table 5. Accel/Decel Time Range Setting

2S NOTCH	ACCEL/DECEL TIME SETTING RANGE (SEC)
0	0.2-6
1 (Factory Setting)	1.8-18
2	6-60
3	18-180
4	60-600
5 - D	180-1800
E	0
F	For Calibrating freq meter

(3) Selection of sequence mode (3S)

The standard sequence mode selector switch (3S) is factory-set (and paint-locked) to notch 0

Notches 1 thru F provide sequences for special applications. For details, contact your Louis Allis Sales representative.

(4) Setting of electronic thermal overload setting switch (4S)

Switch 4S is factory-set at notch E. When a motor has a capacity different from the maximum applicable capacity of the Converter, this setting can be changed to better protect the motor. For details, contact your Louis Allis Sales representative

(5) Selection of Converter capacity (5S)

Switch 5S has been factory-set to agree with the Converter capacity as shown in Table 8 DO NOT CHANGE.

Table 8. Converter Capacity Selection

CONVERTER H.P.	INPUT VOLTS	5S SETTING
.5	23Ø, 46Ø	1
1	23Ø, 46Ø	
3	23Ø, 46Ø	2
5	23Ø, 46Ø	3
7.5	23Ø, 46Ø	
1Ø	23Ø, 46Ø	4
15	23Ø, 46Ø	4
2Ø	23Ø, 46Ø	5
25	23Ø, 46Ø	5
3Ø	23Ø, 46Ø	6
4Ø	23Ø, 46Ø	7
5Ø	23Ø, 46Ø	7
6Ø	23Ø, 46Ø	8
75	23Ø, 46Ø	8
1ØØ	46Ø	B
15Ø	46Ø	D
2ØØ	46Ø	F
25Ø	46Ø	
3ØØ	46Ø	
35Ø	46Ø	
4ØØ	46Ø	
45Ø	46Ø	
5ØØ	46Ø	
6ØØ	46Ø	

(6) Selection of operation modes (6S)

Select the operation modes from Table 9 according to the application, and set each notch of switch 6S as indicated.

NOTE

For 460V units, notches 1 thru 7 have been factory-set to OFF and 8 to ON.
For 230V units, notches 1 thru 8 have been factory-set to OFF.

Table 9. Selection of Operation Modes

6S NOTCH	FEATURES	DESIRED OPERATION	ON	OFF
1	DC INJECTION AT STOP	DC INJECTION IS APPLIED AFTER CONTROLLED DECELERATION TO 1/4 \emptyset OF MAXIMUM SPEED		X
		MOTOR COASTS BELOW 1/4 \emptyset OF MAXIMUM SPEED.	X	
2	STOPPING MOTOR	CONTROLLED DECELERATION AS PER NOTCH 1.		X
		COAST TO STOP.	X	
3	BRAKING RESISTORS	DYNAMIC BRAKE OPTION IS NOT USED		X
		DYNAMIC BRAKE OPTION IS USED	X	
4	DC INJECTION AT START	DC INJECTION BEFORE STARTING (ANTI-WINDMILLING) FOR 1/5 OF DECELERATION TIME	X	
		NORMAL ACCELERATION OPERATION.		X
5	POWER FAILURE RIDE-THRU	MOTOR COASTS TO STOP AFTER MOMENTARY POWER FAILURE		X
		MOTOR CONTINUES OPERATION IF POWER FAILURE IS LESS THAN 2 SECONDS, OR COASTS TO A STOP IF FAILURE IS GREATER THAN 2 SECONDS	X	

Table 9. Selection of Operation Modes (Continued)

6S NOTCH	FEATURES	DESIRED OPERATION	ON	OFF
6	SPEED SEARCH *	ABILITY TO START INTO A COASTING MOTOR (SPEED SEARCH). <u>IMPORTANT</u> - NOTCH 5 MUST BE ON		X
		SPEED SEARCH OVER-RIDE	X	
7	JOGGING	SOFT JOG OPERATION TO 1/10 SPEED.	X	
		NORMAL JOG OPERATION AT 1/10 SPEED		X
8	SUPPLY VOLTAGE **	230V		X
		460V	X	

* Drive output frequency is synchronized with motor speed, then motor is accelerated back to set speed

** DO NOT CHANGE.

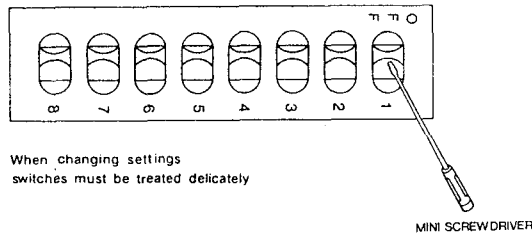

Figure 11. Switch 6S.

(7) Selection of master frequency reference signal

Input terminal 9 will accept either a current signal (4 to 20mA) or a voltage signal (0 to 10VDC).

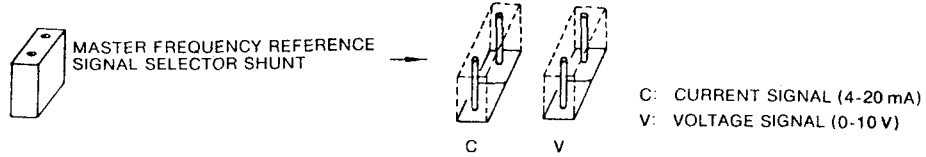

Figure 12. Master Frequency Reference Signal Selection

(8) Selection of auxiliary frequency reference signal

When the shunt is in the (R) position, terminal 21 can be used as a frequency reference input. If the shunt is in the (L) position, terminal 21 will not be operable.

The shunt is factory-set to (R) and must be changed to the (L) position when using the Analog Operator option.

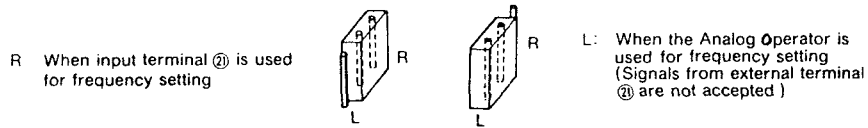

Figure 13. Auxiliary Frequency Reference Signal Selection

(9) Selection of supply voltage (460V units only)

Connect the shunt according to the supply voltage level. The voltage shunt comes preset in the 460V position and should not be changed unless undervoltage tripping occurs.

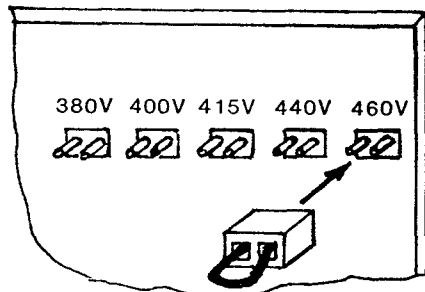

Figure 14. Voltage Selector.

(10) Selection of radio noise reducing filter circuit (460 volt units only)

The RF noise filter is factory set to the "ON" position. Its function is to reduce the amount of RF noise that can be emitted by the Converter.

NOTE

When a separate ground fault interrupter is used, this circuit should be changed to the "OFF" position to prevent false tripping.

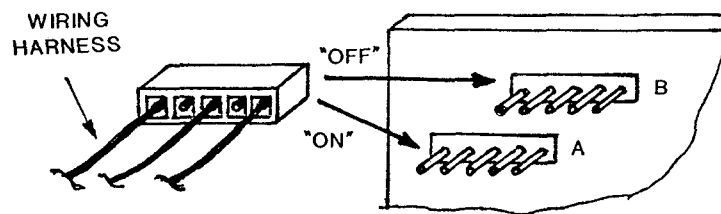

Figure 15. Radio Noise Filter Circuit Shunt.

6. MAINTENANCE

The Converter requires almost no routine checks. It will provide efficient and reliable service if it is kept clean, cool and dry, observing precautions listed in Section 3 1 Check for tightness of electrical connections, component discoloration or other signs of overheating Use Table 10 as the inspection guide.

CAUTION

BEFORE INSPECTING, TURN OFF THE AC INPUT
POWER AND ALLOW THE "CHARGE" LAMP TO GO OUT.

Table 10. Periodic Inspection.

COMPONENT	CHECK	CORRECTIVE ACTION
EXTERNAL TERMINALS, UNIT MOUNTING BOLTS, CONNECTORS, ETC.	LOOSE SCREWS	TIGHTEN
	LOOSE CONNECTORS.	TIGHTEN
HEAT SINK COOLING FINS	BUILD-UP OF DUST AND DIRT	CLEAN WITH DRY COMPRESSED AIR (15 TO 30 PSI)
PRINTED CIRCUIT BOARDS	FOR BUILD-UP OF CONDUCTIVE DUST AND OIL MIST	CLEAN THE BOARD IF DUST AND OIL CANNOT BE REMOVED, REPLACE THE BOARD
	DISCOLORATION DUE TO HEAT	REPLACE THE BOARD
POWER ELEMENTS	ACCUMULATION OF DUST AND DIRT.	CLEAN WITH DRY COMPRESSED AIR (15 TO 30 PSI)
FILTER CAPACITOR	DISCOLORATION OR ODOR	REPLACE THE CAPACITOR

7. FAILURE INDICATION AND DETAILS

A failure, when detected, will shut off the output power transistors and output a FAULT signal by contact closure at Converter terminals 14, 15, and 16.

When an Analog or Digital Operator is used, failure indications listed in Table 11 will function; otherwise failure conditions are shown by the two FAULT lamps (F1 and F2) on the Control PCB in the Converter, as listed in Table 12

Table 11. Failure Indication with an Analog or Digital Operator.





















INDICATION ±	CAUSE
UV* OR (UU +) (UNDERVOLTAGE)	DC BUS VOLTAGE LOWER THAN APPROX. 450V FOR 460V UNITS, 225V FOR 230V UNITS.
OV OR (OU+) (OVERVOLTAGE)	DC BUS VOLTAGE HIGHER THAN APPROX. 790V FOR 460V UNITS, 395V FOR 230V UNITS.
OC (OVERCURRENT)	200 PERCENT OF RATED CURRENT WAS EXCEEDED. (INSTANTANEOUS OPERATION)
OL (OVERLOAD)	OVERLOAD OF MOTOR AND CONVERTER DETECTED BY ELECTRONIC THERMAL CIRCUIT
OH (HEAT SINK OVERHEAT)	THERMOSWITCH OPERATED BY OVERHEATING OF MAIN CIRCUIT SEMICONDUCTOR HEAT SINK.
CPF (CONTROL FUNCTION ERROR)	DETECTION OF CPU FAILURE OR MAIN CONTROL FUNCTION BY SELF-DIAGNOSTIC FUNCTION
EB (OR Eb+) (EXTERNAL FAULT)	EXTERNAL FAULT SIGNAL INPUT AT CONVERTER TERMINAL 7
FU (BLOWN FUSE)	MAIN CIRCUIT FUSE BLOWN.

* Operation continues after a momentary power failure when notch 5 of switch 6S is ON; UV lamp or display flashes for approximately two seconds.

+ For Digital Operator display.

± FAULT will be displayed with individual failure indication on the screen of Digital Operator

Table 12. Failure Indication on Control PCB.

INDICATION		CAUSE
F1	F2	
		FU (FUSE BLOWN): MAIN CIRCUIT FUSE BLOWN
		OC (OVERCURRENT): MORE THAN 200 PERCENT OF RATED CURRENT WAS REQUIRED
		OC (OVERLOAD): ELECTRONIC THERMAL CIRCUIT DETECTED MOTOR AND CONVERTER OVERLOAD.
		OV (OVERVOLTAGE): DC BUS VOLTAGE HIGHER THAN 790V FOR 460V UNITS, 395 FOR 230V UNITS.
		UV1 (UNDERVOLTAGE): DC BUS LOWER THAN SPEC WITH 6S-5 SET TO ON (BLINKS FOR 2 SEC.)
		UV2 (UNDERVOLTAGE): DC BUS LOWER THAN 450V FOR 460V UNITS, 225V FOR 230V UNITS
		OH (OVERHEAT): THERMOSWITCH ON SEMICONDUCTOR HEAT SINK DETECTED EXCESSIVE TEMPERATURE
		EB (EXTERNAL FAULT): EXTERNAL FAULT SIGNAL INPUT AT CONVERTER TERMINAL 7.
		CPF (CONTROL FUNCTION ERROR): CPU FAILURE
		CPF-SEL (SELECTION ERROR): SWITCH 1S THRU 6S CHANGED WITH POWER ON.

NOTE: INDICATION STATUS IS AS FOLLOWS:





-  LIGHT OFF
-  BLINKING AT EQUAL INTERVALS.
-  BLINKING AT SHORT-LONG INTERVALS
-  LIGHT ON STEADY

Table 13. Measuring Points and Instruments.

ITEM	POINTS	INSTRUMENTS	NOTE
SUPPLY VOLTAGE	L1-L2 L2-L3 L3-L1	VOLTMETER: RECTIFIER OR MOVING IRON TYPE	
SUPPLY CURRENT	L1, L2 L3	AMMETER: MOVING IRON TYPE	
SUPPLY POWER	W(L1), W(L2), W(L3)	WATTMETER: ELECTRODYNAMOMETER TYPE (INCORPORATING A HALL GENERATOR)	$P1 = W(L1) + W(L2) + W(L3)$
OUTPUT VOLTAGE	T1-T2 T2-T3 T3-T1	VOLTMETER: RECTIFIER TYPE ONLY	1000 V SCALE (460V) 500V SCALE (230V)
OUTPUT CURRENT	T1, T2 T3	AMMETER: MOVING IRON TYPE	
OUTPUT POWER	W(T1), W(T2), W(T3)	WATTMETER: ELECTRODYNAMOMETER	$P2 = W(T1) + W(T2) + W(T3)$
FREQUENCY SETTING SIGNAL	9(+) TO 10 21(+) TO 20	VOLTMETER: MOVING-COIL TYPE INTERNAL RESISTANCE 50K OHM MAXIMUM	0 TO 10 VDC
FREQUENCY MONITOR	17(+) TO 18		10 VDC AT MAX SPEED AND UNLOADED

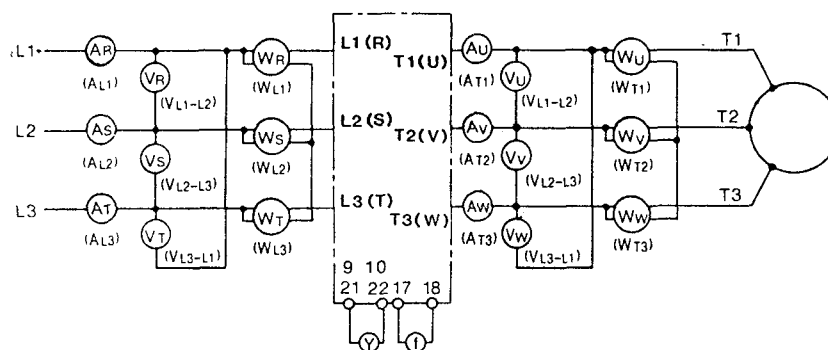

Figure 16.

Figure 17 shows an example of actually measured output voltage. The rectifier type instruments may give different readings depending on the type used.

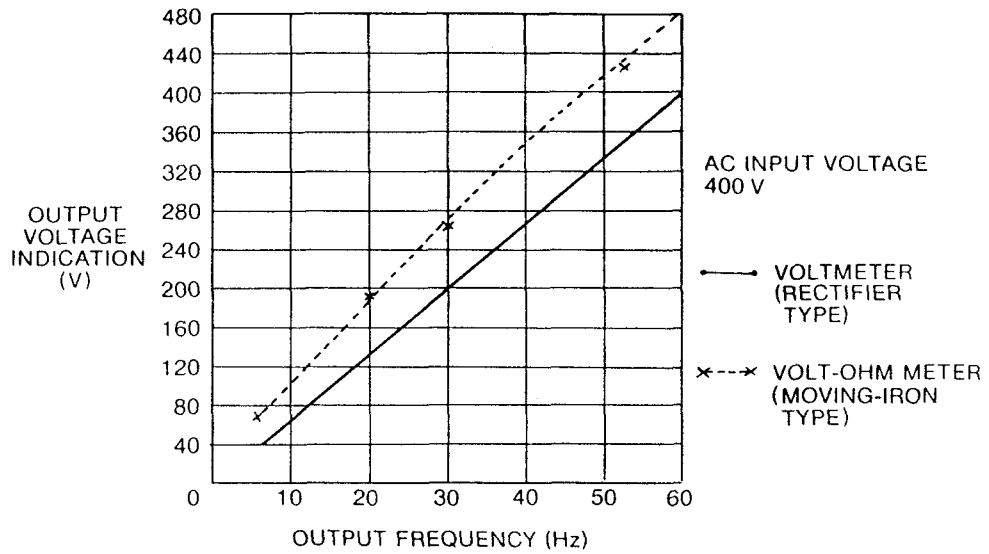
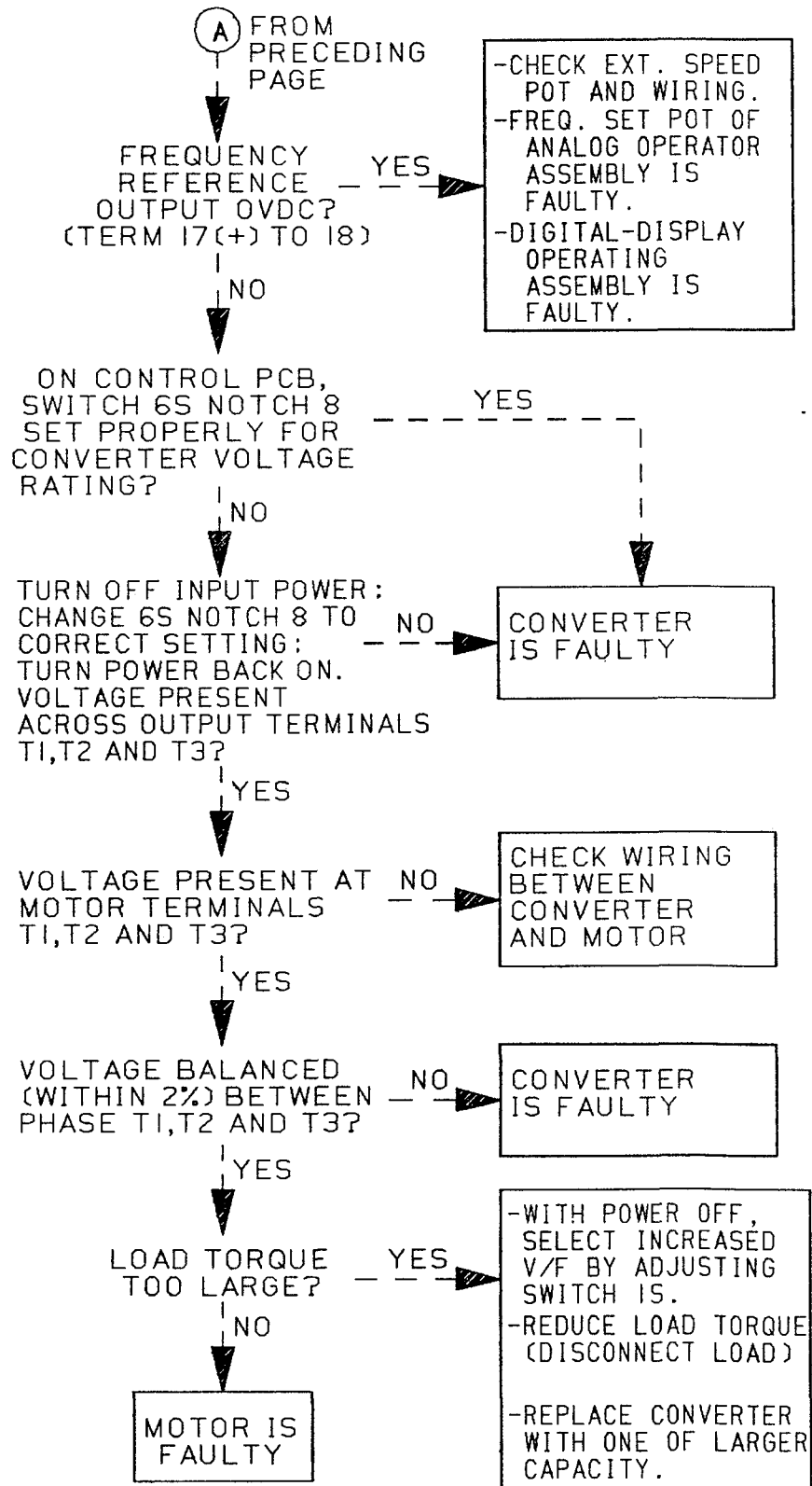

Figure 17.

TROUBLESHOOTING CHART 8.1 (Continued)



TROUBLESHOOTING CHART 8.2

MOTOR STALLS DURING ACCELERATION

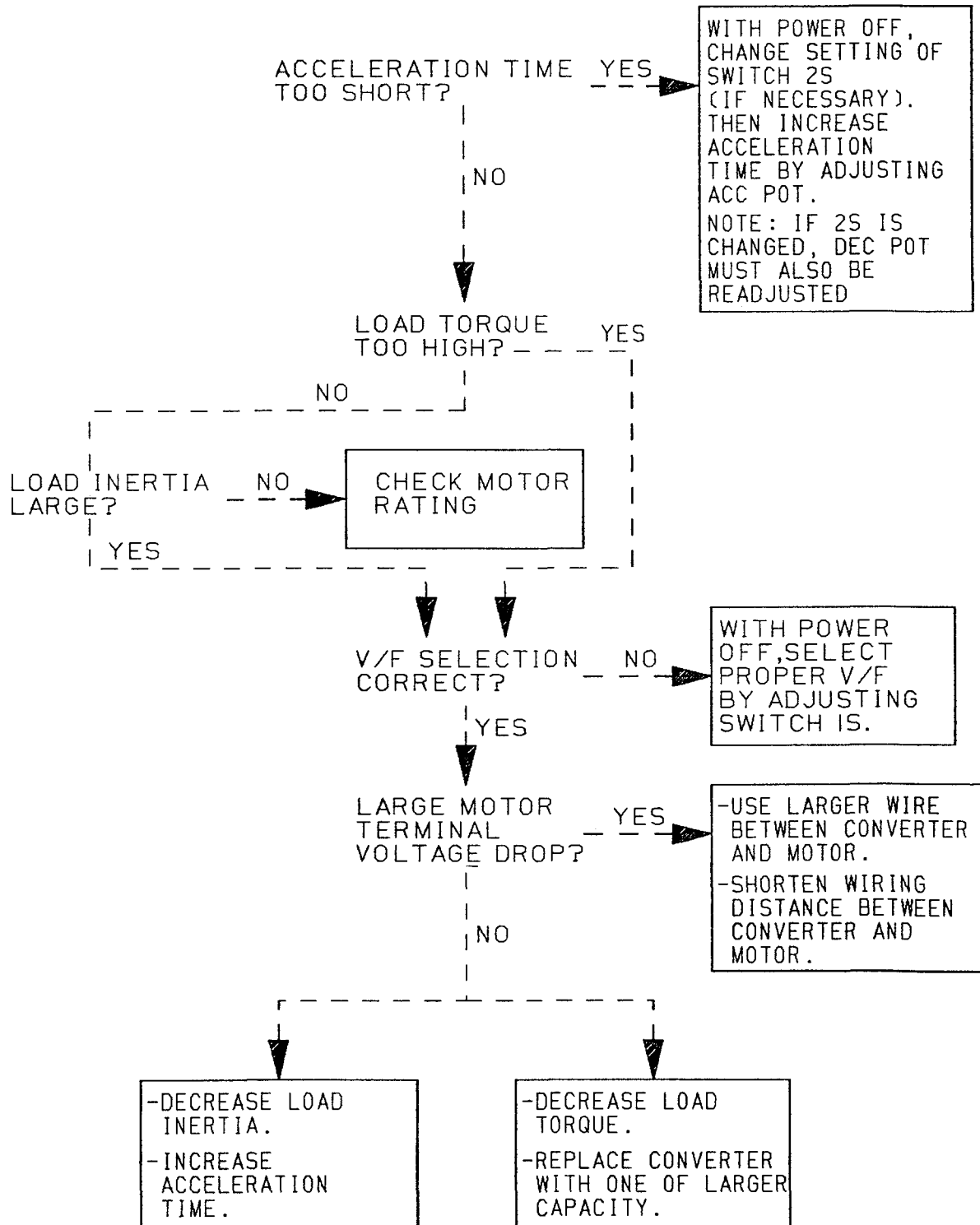

TROUBLE SHOOTING CHART 8.3

OVERVOLTAGE (OV OR OU) FAULT INDICATION

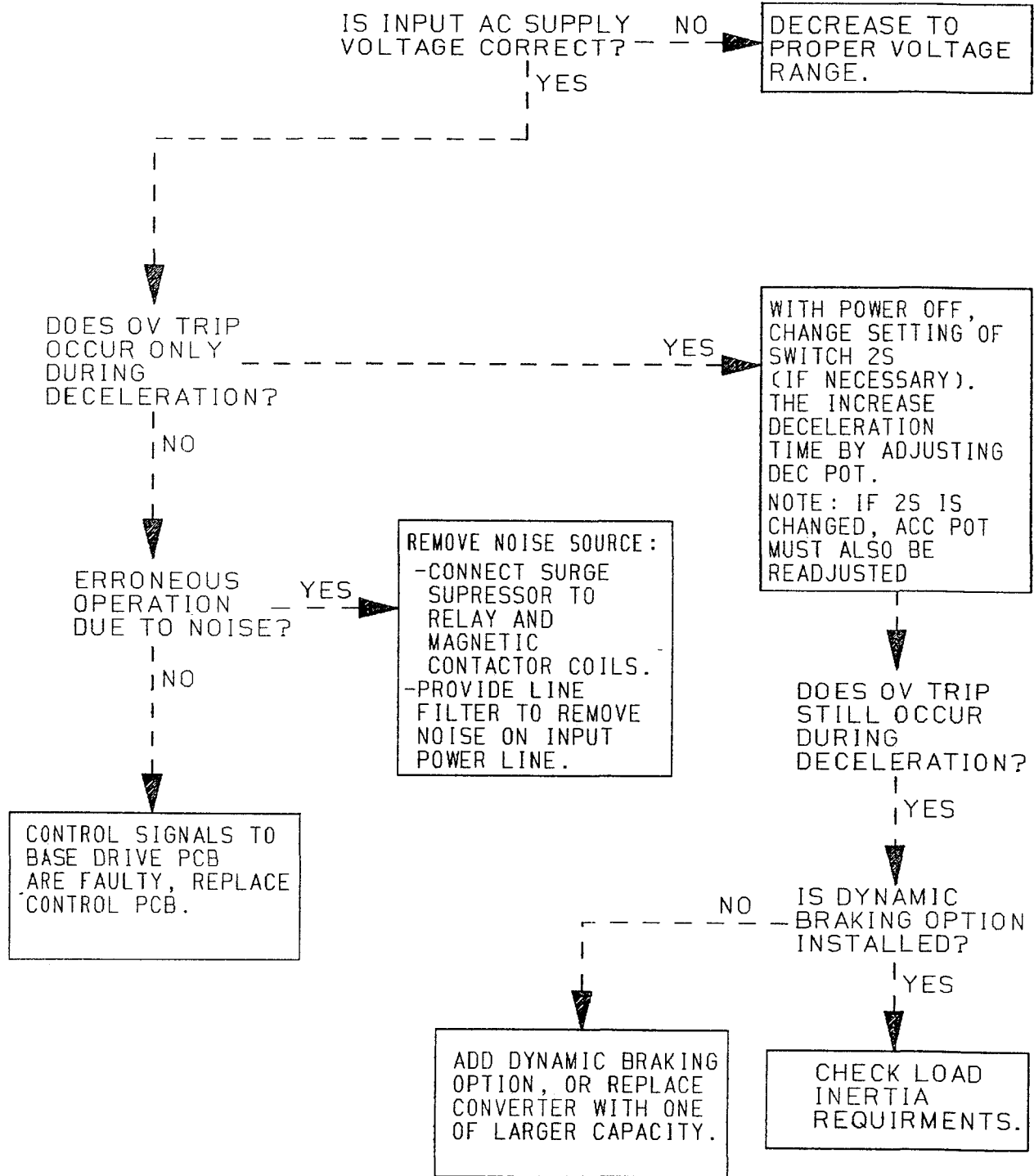

TROUBLESHOOTING CHART 8.4

OVERCURRENT (OC) FAULT INDICATION

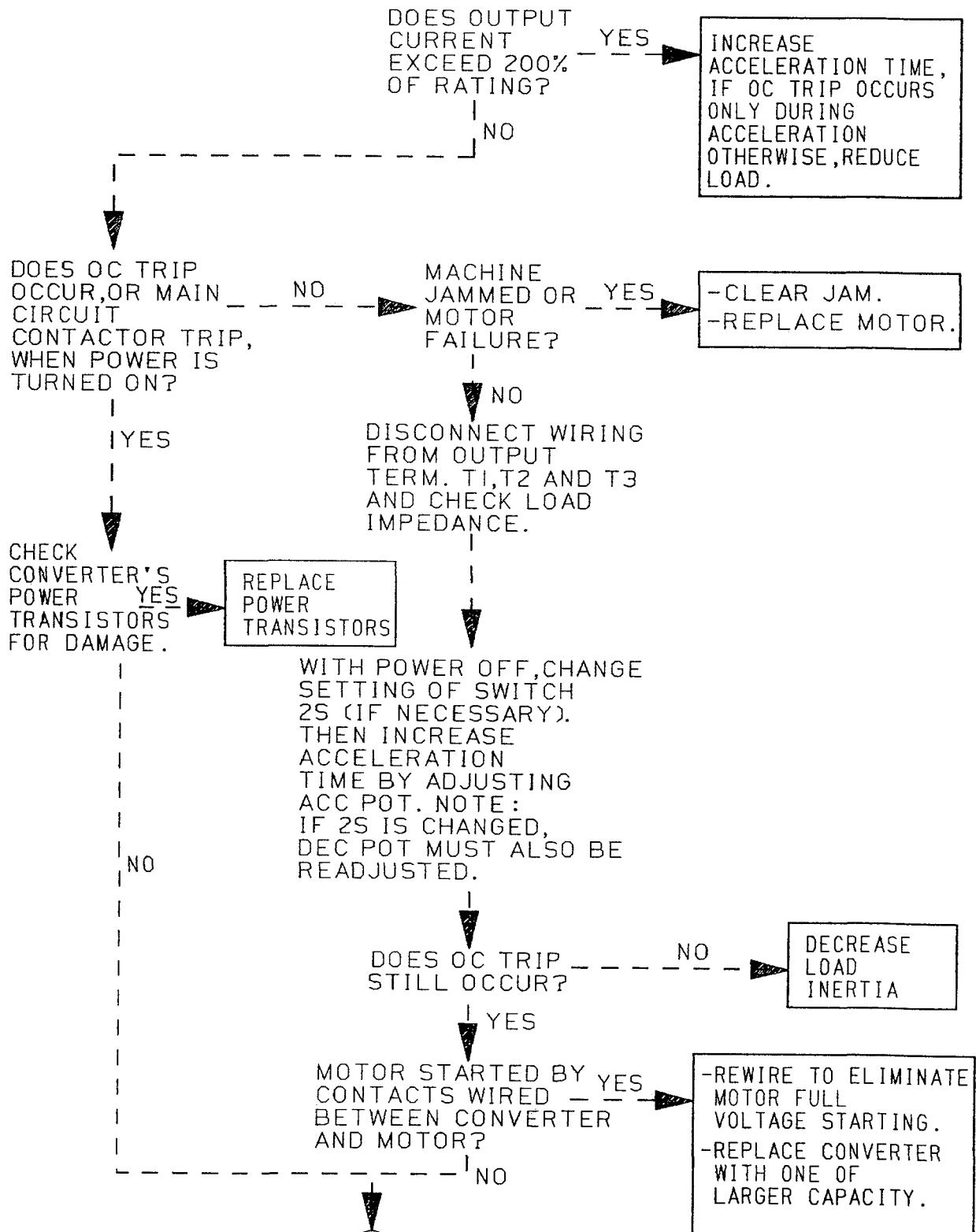

TROUBLESHOOTING CHART 8.4 (Continued)

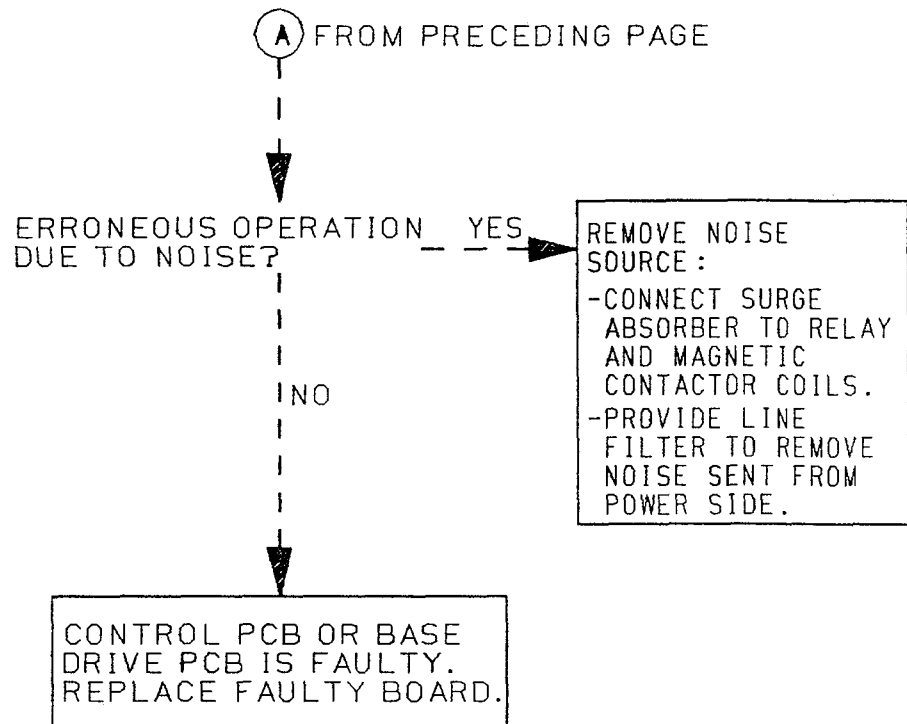

TROUBLESHOOTING CHART 8.5

OVERLOAD (OL) FAULT INDICATION

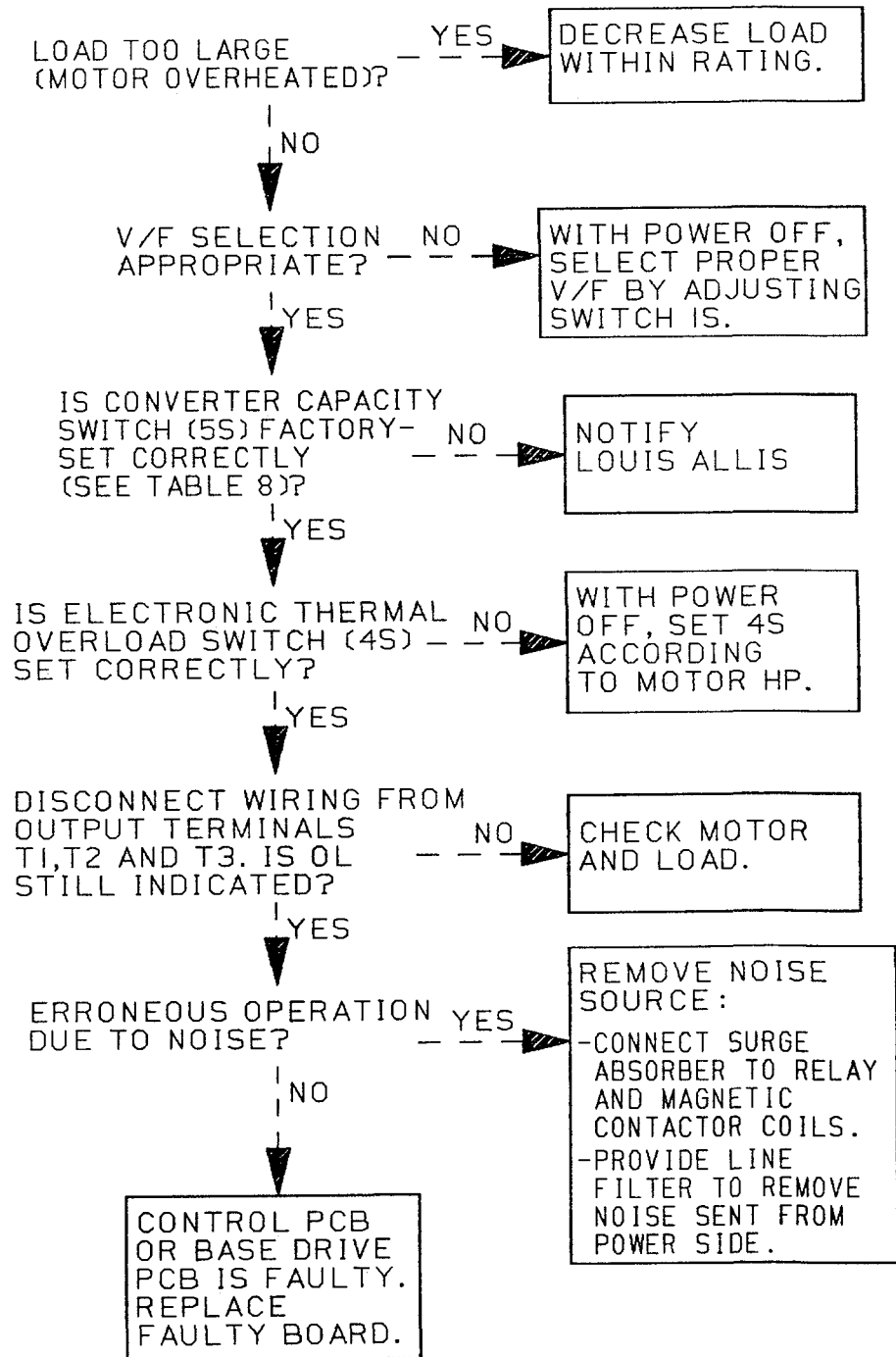

TROUBLESHOOTING CHART 8.6

UNDERVOLTAGE (UV OR UU) FAULT INDICATION

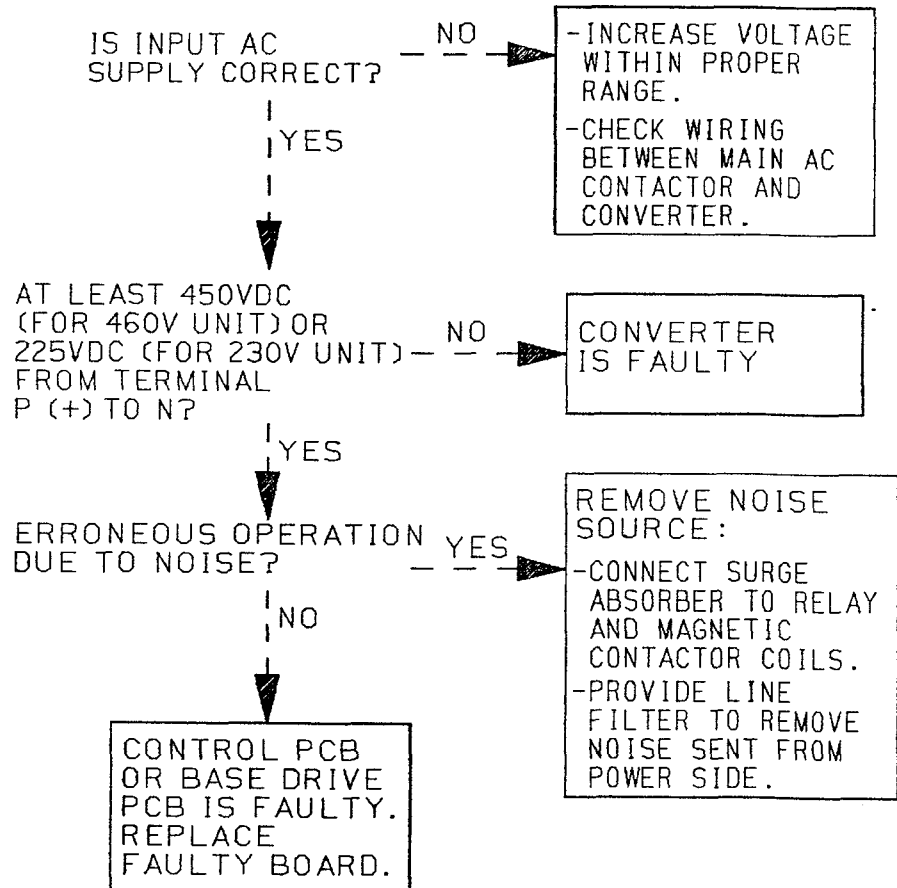

TROUBLESHOOTING CHART 8.7

CONVERTER OVERHEATED (OH) FAULT INDICATION

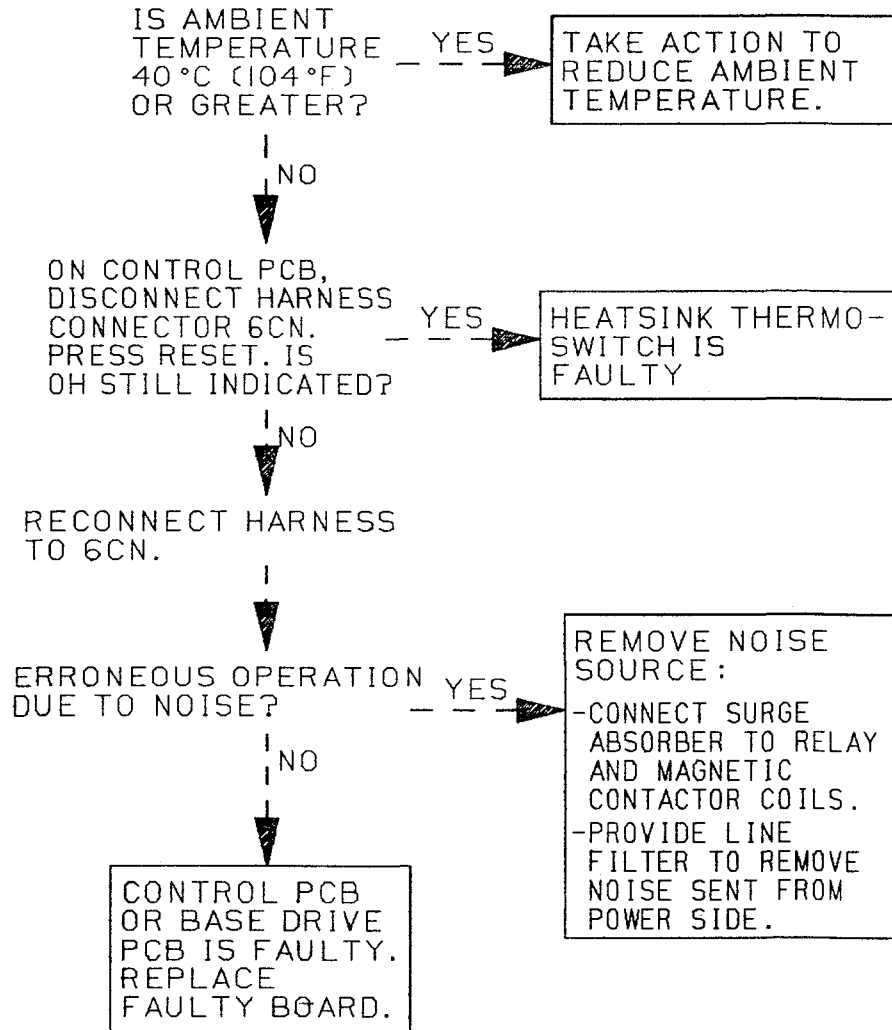

TROUBLESHOOTING CHART 8.8

CONTROL FUNCTION ERROR (CPF) FAULT INDICATION

TURN OFF POWER
AFTER "CHARGE"
LAMP GOES OUT,
TURN POWER BACK ON.

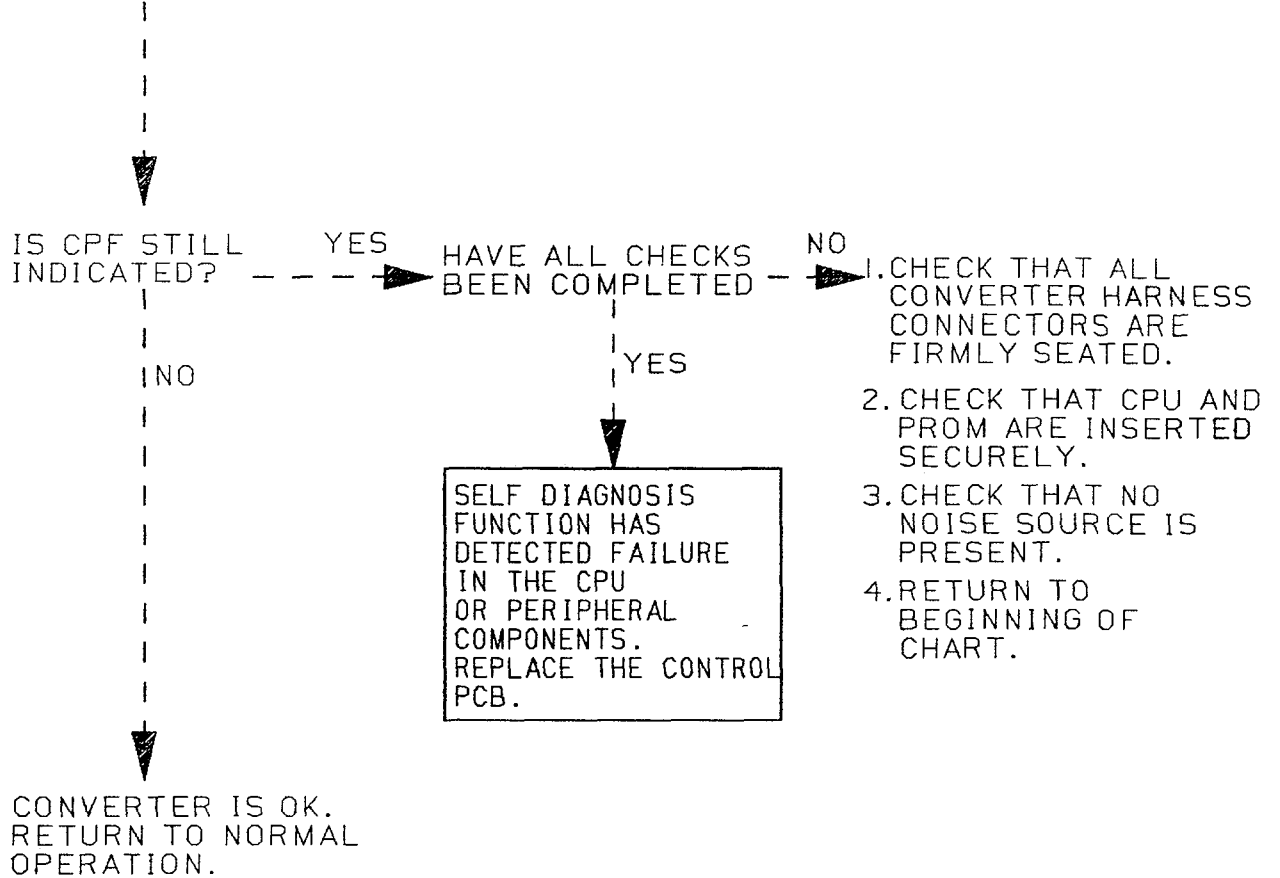

TROUBLESHOOTING CHART 8.9

EXTERNAL FAULT (EB OR Eb) INDICATION

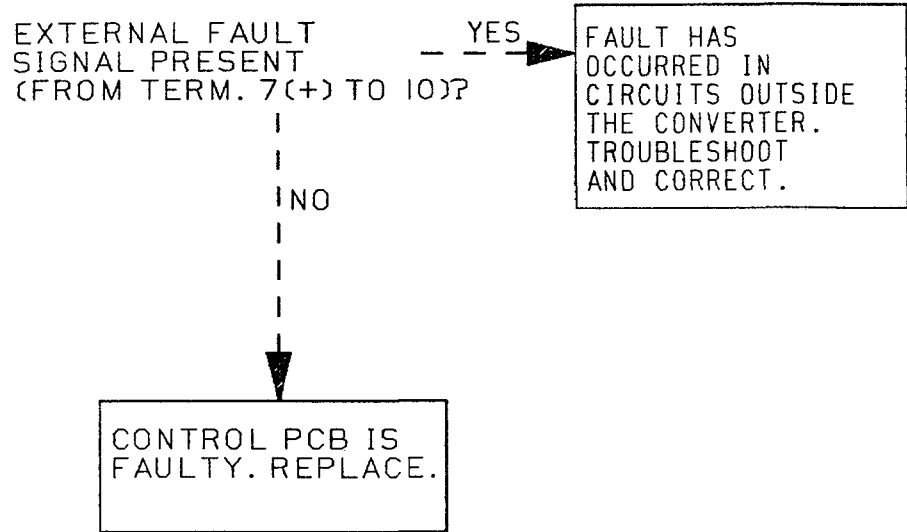

APPENDIX 1. RATINGS AND SPECIFICATIONS

Ratings and Specifications
230 Volt Units

POWER INPUT

Voltage: 208-230 Volts AC \pm 10%
Phase: Three (3)
Frequency: 50/60 Hertz \pm 5%

POWER OUTPUT

Voltage: 0 to 208-230 Volts AC
Phase: Three (3)
Frequency: Max 50, 60, 72, 90, 120, 180
Wave Form: Sine coded PWM
Frequency Range: 40 to 1

230 Volt

MAX HP	OUTPUT KVA	OUTPUT AMPS
.5	1.3	3.3
1	2.0	5.0
3	4.0	10.0
5	6.9	17.0
7.5	10.0	25.0
10	13.1	33.0
15	19.9	50.0
20	21.1	53.0
25	26.3	66.0

MAX HP	OUTPUT KVA	OUTPUT AMPS
30	33.1	83.0
40	39.8	100.0
50	51.8	130.0
60	65.7	165.0
75	79.7	200.0
100	91.6	230.0
125	131.5	330.0

Ratings and Specifications
460 Volt Units

POWER INPUT

Voltage: 460 Volts AC \pm 10%
 Phase: Three (3)
 Frequency: 50/60 Hertz \pm 5%

POWER OUTPUT

Voltage: 0 to 460 Volts AC
 Phase: Three (3)
 Frequency: Max 50, 60, 72, 90, 120, 180
 Wave Form: Sine coded PWM
 Frequency Range: 40 to 1

460 Volt

MAX HP	OUTPUT KVA	OUTPUT AMPS
.5	1.4	1.7
1	2.0	2.5
3	4.0	5.0
5	7.2	9.0
7.5	10.4	13.0
10	13.5	17.0
15	15.1	19.0
20	19.9	25.0
25	26.3	33.0
30	33.5	42.0
40	39.9	50.0

MAX HP	OUTPUT KVA	OUTPUT AMPS
50	52.6	66.0
60	66.1	83.0
75	79.7	100.0
100	100.0	125.0
150	143.0	180.0
200	183.0	230.0
250	239.0	300.0
300	263.0	330.0
350	329.0	410.0
400	347.0	436.0
450	393.0	490.0
500	478.0	600.0
600	529.0	660.0

Specifications - All Units

Frequency Accuracy: Digital command $\pm 0.01\%$ (-10 to 40°C)
Analog command $\pm 0.2\%$ ($25^{\circ} \pm 10^{\circ}\text{C}$)

ENVIRONMENTAL SPECIFICATION

Ambient Temperature: Operating -10 to 40°C (14 to 104°F)
Storage -20 to 60°C (-4 to 140°F)
Humidity: Up to 90% Relative (Non-Condensing)
Altitude: Up to 3,300 Feet Above Sea Level

STANDARD FEATURES

Volts per Hertz: Constant or Variable (15 selectable curves total)
Low Frequency Voltage Boost: 4 selectable curves
Acceleration Time: Adjustable 2 to 1800 Seconds
Deceleration Time: Adjustable .2 to 1800 Seconds
Electronic Reversing: Standard
Speed Setting Signal Inputs: 0 to 10 VDC
(Input Impedance: 20K Ohms)
4 to 20 mA DC
(Input Impedance: 500 Ohms)
Overcurrent Capacity: 150% for 60 seconds
Regenerative Braking Torque: Approximately 20% of Rated Full Load Torque
Isolated: Low Voltage DC Control Circuit

PROTECTIVE FEATURES

Power Failure Ride-Thru: .2 sec or *2 sec (switch selectable)
* Added external capacitor required on 460V units
Undervoltage: Drive trips below 85% of Rated Line Voltage
Overvoltage: Drive trips above 115% of Rated Line Voltage
Overcurrent: Drive trips if 150% of Rated Current exists for 60 seconds or more
Overtemperature: Drive trips if heat sink exceeds a safe operating temperature
Current Limited Stall Prevention: Operates during acceleration, deceleration, and while motoring
Trip Diagnostics: Two FAULT LED's indicate the type of trip by varying illumination
Ground Fault: Drive trips if a Phase-to-Ground short occurs. (Not available on 230 Volt units less than 15 HP)
Instantaneous Overcurrent: Trip occurs at 200% of Rated Output Current

SPECIAL FEATURES (SWITCH SELECTABLE)

Speed Search: Allows the Converter to start a coasting motor
Anti-Windmill Protection: DC Injection before motor acceleration
DC Braking: DC injection below 1/40 of Rated Frequency
Electronic Thermal Motor Overload: Provides thermal protection for the motor when motor HP is less than or equal to the Converter Rating

APPENDIX 2. TERMINAL FUNCTIONS

Terminal Functions and Voltage of Main Circuit

Table 15a. .5-10 HP, 230 Volts

TERMINALS	FUNCTIONS	LEVELS
L1 L2 L3	MAIN CIRCUIT INPUT POWER SUPPLY	THREE PHASE 208-230 VAC, AT 50/60 HZ (VOLTAGE FLUCTUATION $\pm 10\%$)
1 2	COOLING FAN INPUT POWER SUPPLY (FOR 7.5 AND 10 HP)	SINGLE PHASE (FROM INPUT POWER SUPPLY)
T1 T2 T3	OUTPUT	THREE PHASE 208-230 VAC MAXIMUM (CORRESPONDING TO INPUT VOLTAGE)
B1, B2 a, b	BRAKING MODULE (INTERNAL MOUNTING OPTION)	0 OR TO APPROXIMATELY 300 VDC
B3, N	BRAKING RESISTOR UNIT *	
P+ TO N-	MAIN CIRCUIT DC POWER SUPPLY	APPROXIMATELY 300 VDC
GND	GROUND TERMINAL	

* External option, used with braking module

Table 15b. 15-125 HP, 230 Volts

TERMINALS	FUNCTIONS	LEVELS
L1 L2 L3	MAIN CIRCUIT INPUT POWER SUPPLY	THREE PHASE 208-230 VAC, AT 50/60 HZ (VOLTAGE FLUCTUATION $\pm 10\%$)
1 2	COOLING FAN INPUT POWER SUPPLY	SINGLE PHASE (FROM INPUT POWER SUPPLY)
T1 T2 T3	OUTPUT	THREE PHASE 208-230 VAC MAXIMUM (CORRESPONDING TO INPUT VOLTAGE)
P1 TO N-	BRAKING UNIT *	0 - APPROXIMATELY 300 VDC
P1, P2, P3 TO N-	MAIN CIRCUIT DC POWER SUPPLY	APPROXIMATELY 300 VDC
GND	GROUND TERMINAL	

*External option.

Table 15c. .5-150 HP, 460 Volts

TERMINALS	FUNCTIONS	LEVELS
L1 L2 L3	MAIN CIRCUIT INPUT POWER SUPPLY	3-PHASE 460 VAC AT 50/60 HZ (VOLTAGE FLUCTUATION $\pm 10\%$)
1 2	CONTROL CIRCUIT INPUT POWER SUPPLY	SINGLE-PHASE (FROM INPUT POWER SUPPLY)
T1 T2 T3	OUTPUT	3-PHASE 460 VAC (CORRESPONDING TO INPUT VOLTAGE)
P1, P2	DC REACTOR FOR POWER FACTOR CORRECTION	
P3 TO N-	EXTERNAL CAPACITOR (UP TO THE SAME CAPACITY OF CAPACITOR INCORPORATED IN CONVERTER)	APPROXIMATELY 600 VDC
P1 TO N-	BRAKING UNIT*	0 TO APPROXIMATELY 600 VDC
P1, N, P2	MAIN CIRCUIT DC POWER SUPPLY	APPROXIMATELY 600 VDC
C1, C2	BACKUP CAPACITOR FOR MOMENTARY FAILURE	APPROXIMATELY 300 VDC
V1, V2	POWER SUPPLY TO EXTERNAL EQUIPMENT	220V, 50/60 HZ
GND	GROUND TERMINAL	

* External option.

Table 15d. 200-600 HP, 460 Volts

TERMINALS	FUNCTIONS	LEVELS
L1 L2 L3	MAIN CIRCUIT INPUT POWER SUPPLY	3-PHASE 460 VAC AT 50/60 HZ (VOLTAGE FLUCTUATION $\pm 10\%$)
1 2 3	CONTROL CIRCUIT INPUT POWER SUPPLY	3-PHASE (FROM INPUT POWER SUPPLY)
T1 T2 T3	OUTPUT	3-PHASE 460 VAC (CORRESPONDING TO INPUT VOLTAGE)
P1, P2	DC REACTOR FOR POWER FACTOR CORRECTION	
P3 TO N	EXTERNAL CAPACITOR (UP TO THE SAME CAPACITY OF CAPACITOR INCORPORATED IN CONVERTER)	APPROX 600 DC
P1 TO N	BRAKING UNIT *	0 TO APPROXIMATELY 600 VDC
P1,P2 TO N	MAIN CIRCUIT DC POWER SUPPLY	APPROXIMATELY 600 VDC
C1, C2	BACKUP CAPACITOR FOR MOMENTARY POWER FAILURE	APPROXIMATELY 300 VDC
V1, V2	POWER SUPPLY TO EXTERNAL EQUIPMENT	220V, 50/60 HZ
GND	GROUND TERMINAL	

* External option.

Table 16. Terminal Functions and Signals of Control Circuit

TERMINALS	FUNCTIONS	LEVELS
1	CONTROL CIRCUIT INPUT COMMON	COMMON
2	RUN SIGNAL	RUN AT CLOSED*
3	STOP SIGNAL	STOP AT OPEN+
4	CONNECTION TO SHIELD OF SIGNAL LEAD	GND.
5	FWD/REV OPERATION SELECTOR	FORWARD AT OPEN+, REV AT CLOSED*
6	AUTO/MAN FREQUENCY SIGNAL SELECTOR	AUTO SPEED AT OPEN+, MAN AT CLOSED*
7	EXTERNAL FAULT INPUT	EXTERNAL FAULT AT CLOSED*
8	FAULT RESET INPUT (EXTERNAL)	FAULT RESET AT CLOSED*
9 10	"AUTO" MODE FREQUENCY SIGNAL INPUT	0 TO +10V (20K OHM) OR 4-20 MA (500 OHM) COMMON
11	CONNECTION TO SHIELD OF SIGNAL LEAD	GND.
12 13	RUN CONTACT OUTPUT (1 N.O.) CLOSED DURING RUN	CONTACT CAPACITY: 250 VAC AT 1A 30 VDC AT 1A
14 COM 15 N.C. 16 N.O.	FAULT CONTACTOR OUTPUT (FORM C) N.C. OPEN AT FAULT N.O. CLOSED AT FAULT	CONTACT CAPACITY: 250 VAC AT 1A 30 VDC AT 1A
17	FREQUENCY METER	APPROXIMATELY +10 V/100%, OUTPUT IMPEDANCE, 3K OHM
18		COMMON
19	CONNECTION TO SHIELD OF SIGNAL LEAD	GND.
20 21 22	"MAN" MODE FREQUENCY SIGNAL INPUT	+15V (20MA MAX) 0 TO 10 VDC COMMON

* Short-circuited with terminal 1.
+ Not shorted to terminal 1.

APPENDIX 3. OPTIONS

Table 17.

NAME	FUNCTIONS
DIGITAL OPERATOR	MOUNTED ON THE CONVERTER WITH CONNECTION TO CONTROL PCB. ISSUES OPERATION COMMANDS, SETS THE FREQUENCY BY THE DIGITAL SIGNAL. DISPLAYS THE PRESET OR CURRENT FREQUENCY IN DIGITAL FORM. ALSO, DISPLAYS FAULT CODE WHEN A FAILURE OCCURS.
ANALOG OPERATOR	MOUNTED ON THE CONVERTER WITH CONNECTION TO CONTROL PCB. GIVES OPERATION COMMANDS, SETS THE FREQUENCY BY THE ANALOG SIGNAL. INDICATES THE CURRENT FREQUENCY ON THE FREQUENCY METER. ALSO, WHEN A FAILURE OCCURS, TYPE OF FAULT IS IDENTIFIED BY LAMP ILLUMINATION.
PROGRAMMING OPERATOR	WHEN A CONTROL EXPANSION OPTION IS PRESENT, ALLOWS PROGRAMMING OF CONSTANTS IN THAT OPTION'S EEPROM OTHERWISE FUNCTIONS THE SAME AS DIGITAL OPERATOR
MEMORY MODULE CONTROL EXPANSION	MOUNTS TO SIDE OF CONVERTER ENCLOSURE, WITH CONNECTION TO CONTROL PCB. ADDS ADDITIONAL (SETTABLE) CONSTANTS AND BACKUP MEMORY CAPABILITY TO CONTROL CIRCUIT PROGRAMMING.

APPENDIX 4. CHECKING OF DIODE AND TRANSISTOR MODULES

Diode Module

Measure the resistance across the module terminals with a volt-ohm meter. Set the meter at the X1 range. The measured resistance should be within the reference values listed in Table 18.

Table 18. Diode Module Resistances

+	-	NORMAL READING (OHMS)	ABNORMAL READING (OHMS)
ON	ON		
L1	P		
L2	P	1∅	∅
L3	P	T0	OR
N	L1	5∅	INF
N	L2		
N	L3		

+	-	NORMAL READING (OHMS)	ABNORMAL READING (OHMS)
ON	ON		
L1	N		
L2	N		
L3	N	INF	LESS THAN
P	L1		
P	L2		
P	L3		
P	N	MAGNITUDE OF CAP CHARGE TO INF	∅ OR INF

RESISTANCE TEST FOR 3∅ CONVERTER MODULES (BRIDGE RECT)

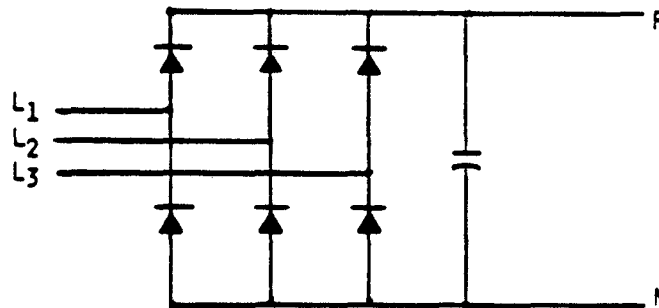

VOM RESISTANCE SCALE RX1
+ IS THE POSITIVE POLARITY LEAD*
- IS THE NEGATIVE POLARITY LEAD

*THE VOM RED LEAD IS NOT NECESSARILY THE POSITIVE POTENTIAL IN THE RESISTANCE MODE. FOR THESE TESTS THE + LEAD REFERS TO THE POSITIVE POTENTIAL. MAKE SURE YOU KNOW WHICH POLARITY YOU HAVE ON YOUR VOM.

Transistor Module

Measure the resistance across the module terminals with a volt-ohm meter. Set the meter to the X1 range. The measured resistance should be within the reference values listed in Table 19.

Table 19. Transistor Module Resistances

+	-	NORMAL READING (OHMS)	ABNORMAL READING (OHMS)
P P P A B C	A B C N N N	GREATER THAN 50K	∅
A B C N N N	P P P A B C	10 TO 50	∅ OR INF

+	-	NORMAL READING (OHMS)	ABNORMAL READING (OHMS)
B1A B1B B1C B2A B2B B2C	A B C N N N	10 TO 50	GREATER THAN 10K
A B C N N N	B1A B1B B1C B2A B2B B2C	200 TO 5K	∅ OR INF

RESISTANCE TEST FOR 30 TRANSISTOR MODULES

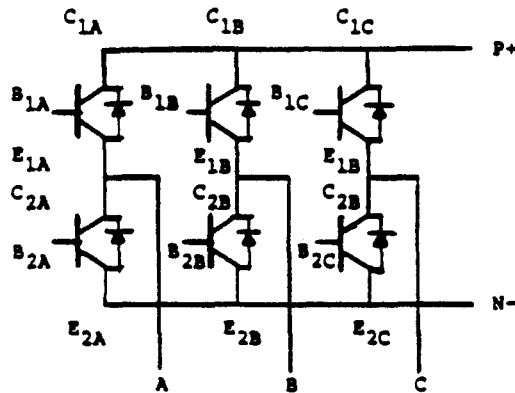

VOM RESISTANCE SCALE RX1
 + IS THE POSITIVE POLARITY LEAD*
 - IS THE NEGATIVE POLARITY LEAD

*THE VOM RED LEAD IS NOT NECESSARILY THE POSITIVE POTENTIAL IN THE RESISTANCE MODE. FOR THESE TESTS THE + LEAD REFERS TO THE POSITIVE POTENTIAL MAKE SURE YOU KNOW WHICH POLARITY YOU HAVE ON YOUR VOM.

APPENDIX 5. SPARE PARTS

Louis Allis recommends the customer stock on-site spare parts to minimize costly down time. Table 20 lists parts which have a high probability of needing replacement.

Table Entry

XXXXXXX
XXXXXXXXX
X

- Item Model Number

- Part Number

- Qty in Converter

Table 20. Recommended Spart Parts

Section A. Wall-Mount Units			
230V		460V	
HP	DC BUS FUSE	HP	DC BUS FUSE
15	CR2L-75 FU000747 1	5, 1 3, 5	80LF-15 FU000760 1
20, 25	CR2L-100 FU000748 1	7.5, 10	80LF-25 FU000761 1
30	CR2L-125 FU000749 1	15, 20, 25	80LF-50 FU000762 1
40	CR2L-150 FU000750 1	30, 40	CR6L-75 FU000757 1
50	CR2L-200 FU000751 1	50	CR6L-100 FU000758 1
60	CR2L-260 FU000752 1	60, 75	CR6L-150 FU000756 1
75	CR2L-300 FU000753 1	100	CR6L-200 FU000755 1
-	-	150	CR6L-300 FU000754 1

Table 20. Recommended Spart Parts (Continued)

Section B. 460V Floor Standing			
HP	INPUT POWER FUSE	DC BUS FUSE	FAN FUSE
200	CS5F-600 FU000616 2	CS10F-350 FU000789 1	FCF-2 FU000597 2
250, 300	CS5F-600 FU000616 2	CS10F-500 FU000680 1	FCF-2 FU000597 2
400, 450	CS5F-800 FU000687 2	CS10F-800-P FU000804 1	
500, 600	CS5F-1000-P FU000802 2	CS10F-1000-P FU000801 1	

Power and control products including Solid State starters, Eddy Current drives, DC drives and Adjustable Frequency drives



16555 W Ryerson Road
New Berlin, Wisconsin 53151

(800) 262-6511, (414) 782-0200, FAX (414) 782-1283